



Bouwmeester Watersport

TORQUEEDO



Electric mobility on the water
2023

ENGLISH

Time to go electric.

We provide everything you need to go electric with fully integrated systems from 0.5 to 200 kW of power, for boats from kayaks to large yachts.

Ultralight

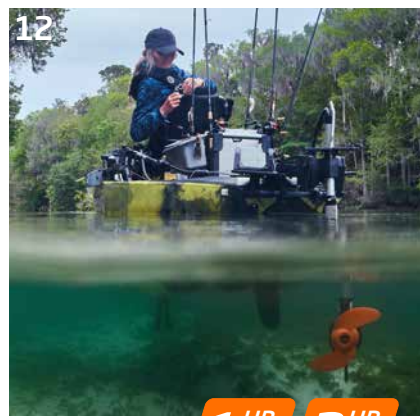

1 HP
equivalent

3 HP
equivalent

Travel

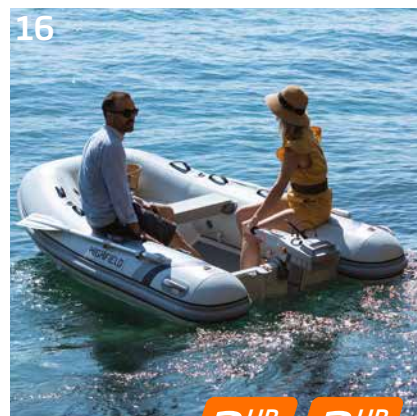

2 HP
equivalent

3 HP
equivalent

Cruise Outboards

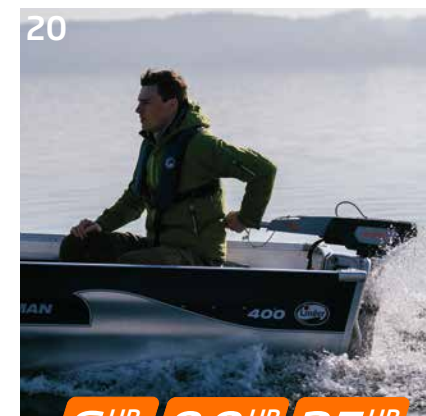

6 HP
equivalent

9.9 HP
equivalent

25 HP
equivalent



ULTRALIGHT 403 A/AC



TRAVEL 603



CRUISE 3.0 R/T



ULTRALIGHT 1103 AC



TRAVEL 1103 C



CRUISE 6.0 R/T

- 4 Newsroom
- 6 Sustainability
- 8 Superior performance
- 10 Advanced engineering
- 28 Power batteries
- 38 Deep Blue battery

- 42 Accessories
- 46 Technical specifications
- 48 Ordering information
- 52 Service and editorial information
- 54 New mobility
- 56 Contact



CRUISE 12.0 R

Cruise Pods



Deep Blue



CRUISE 3.0 FP



DEEP BLUE 25/50 R



DEEP BLUE 100 i 900



CRUISE 6.0 FP



DEEP BLUE 25 SD



DEEP BLUE 100 i 2500



CRUISE 12.0 FP



DEEP BLUE 50 SD



DEEP BLUE 25/50 i

Visit our newsroom

Stay up-to-date with the latest news about Torqeedo products and projects - including customer stories, boatbuilder profiles, tech talks, company insights and press releases on our newsroom.

Filter by your interests

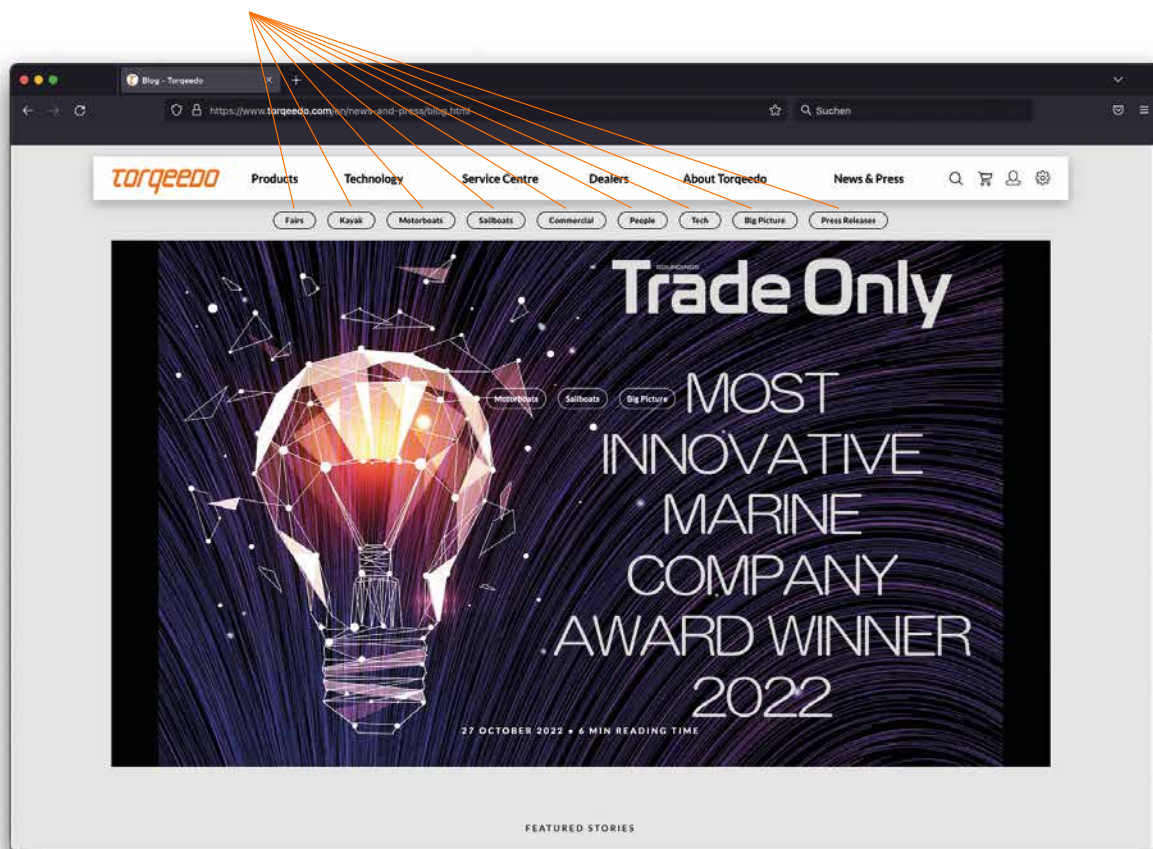

Join the discussion!



www.facebook.com/torqeedo



[@TORQEEDOGmbH](https://twitter.com/TORQEEDOGmbH)



www.instagram.com/torqeedo_group

www.bouwmeesterwatersport.nl

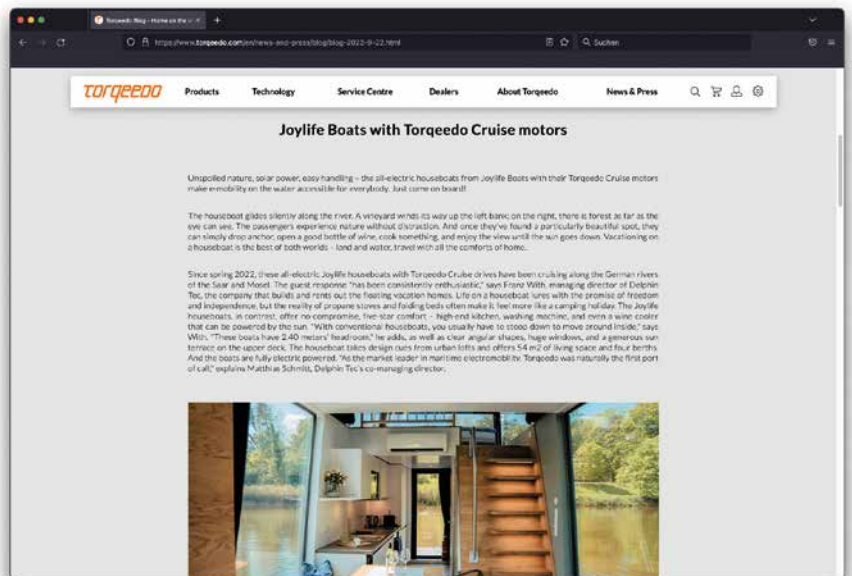
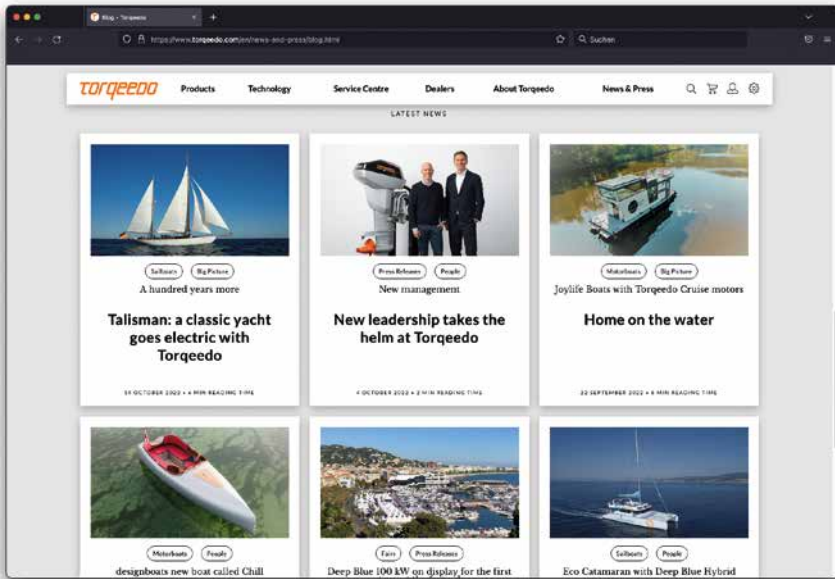

Scan me

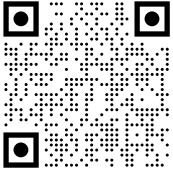

www.torqeedo.com/en/news-and-press/blog.html



Turning the tide

Switching makes a difference. Electric boats are cleaner and healthier for you, your community and our planet.

If you spend time outdoors and on the water, you are likely to have noticed a change. According to the NOAA* analysis of global temperatures, 2013-2021 all ranked within the ten hottest years since 1880, when record-keeping began. It's been 45 years since the earth saw a colder-than-average year, and there is a 93% chance that one of the next five years will be the warmest year in recorded history. Ocean temperatures are rising, as fishermen report species that have sustained coastal communities for ages are vanishing. Coral reefs, so fragile and beautiful, so critical for aquatic life, are suffering from warming and ocean acidification.

The science is clear

There is a 50:50 chance of average global temperature reaching 1.5 degrees Celsius above preindustrial levels in the next five years, and the likelihood is increasing with time. The science is clear: We have to reduce our greenhouse gas emissions by 43% by 2030 to avoid further warming and the most harmful impacts of climate change. Reaching this goal will require the reinvention of our lifestyle.

The good news is that the technology for a carbon-neutral mobility is here - and getting more powerful every day.

Electric boats have lower climate impact

Boats powered by electric motors have a significantly lower climate impact than combustion-powered boats. Even when charged with electricity from a coal-fired power plant, CO₂ emissions are reduced by approximately 30%. When charged via renewables, the climate impact is reduced by up to 90%.

Until recently, little attention was paid to the air pollution caused by combustion engines on boats. They are allowed to emit up to 100 times the level of harmful substances permitted in automotive diesels and include very little technology for filtering out pollutants. If you drive an 80 HP boat for one hour, it's like driving 350 new cars at highway speed for the same amount of time.** It's no wonder that in cities with a lot of boat traffic, air pollution from fine particles is up to 20 times higher than accepted levels. If you switch to an electric drive, you are not only reducing

your carbon footprint; your local community and waters will benefit as well.

Electric boats cause no water pollution because they don't discharge their exhaust underwater like combustion engines and there is no chance of fuel or oil spilling on the boat or fouling the water. They are also quieter than fossil fuel-powered boats, with very little noise to disturb people on land and wildlife under water. With an electric motor the only sound you hear are the sounds of nature.

For now and the future

Boaters are keen to preserve nature and enjoy clean air and unpolluted water - for today's enjoyment and tomorrow's generations. Torqeedo creates the products for the transition to sustainable boating. It's what we've been doing all along.

* National Oceanic and Atmospheric Administration

** Sources: United States Environmental Protection Agency, California Air Resources Board, Environmental Capital Group



Healthier air and climate

Electric motors do not emit toxic substances and typically have a lower carbon footprint due to their superior efficiency and lightweight design.



Zero pollution

Even a drop of spilt petrol can contaminate thousands of litres of water. Electric drives eliminate the oily film that forms where combustion engines are used.



Peace and quiet

Electric motors are quieter and cause less vibration on board than a typical combustion engine.



Abundant green power

Solar panels can help keep batteries charged and some electric motors can charge their own batteries - the spinning prop acts as a hydrogenerator and supplies free, clean energy while the boat is under sail.



More energy onboard

With increased battery capacity, everything from the water maker to the tender can be electric-powered, further reducing climate impacts.



Convenient charging

Charging is quick and easy - most marinas are already equipped with shore power connections.

Superior efficiency and performance

Our focus on optimising propulsive power and overall efficiency



Measuring power and performance

The most meaningful performance indicator of a drive system is propulsive power, which indicates the power delivered by the motor to drive the boat, while taking all losses, including propeller losses, into account. This method has been used in commercial shipbuilding for nearly 100 years.

Manufacturers of combustion engines often advertise less informative measurements, such as the shaft power, input power, or even the static thrust. That wouldn't be so bad if the differences between power ratings were minimal, but that isn't the case: a petrol outboard with an advertised shaft power of 6 HP actually provides a mere 1.6 HP of propulsive power.

The efficiency advantage

Torqueedo efficiency ratings not only refer to motor efficiency, but also disclose losses in motor, electronics, cables, gears and propellers. Thanks to our focus on optimising the entire system, Torqueedo motors deliver the highest overall efficiency on the market. When combustion engines burn petrol or diesel, they primarily use the stored energy to produce heat: 5-15% of the supplied energy is used to propel the boat and the rest is lost due to inefficiencies. A Torqueedo drive converts between 44% and 56% of the available energy into propulsive power, extending range and runtime. A Travel motor can propel a light boat more than 10 nautical miles and only consume the equivalent of 40 g of petrol.

Horsepower equivalent

Electric motors can achieve the same propulsive power as combustion engines with a significantly lower shaft power because of the different torque curves they produce. Electric motors deliver ample torque, which is available at any rotational speed. This characteristic allows them to turn large, efficient, high-pitch propellers that would cause an equivalent combustion engine to stall at startup.

At Torqueedo, we always compare the actual propulsive power of our motors with petrol engines. A Torqueedo motor specified as a "6 HP equivalent" provides the same power as a 6 HP combustion engine, even though its shaft and input power may be lower.



Input power: A performance indicator used for electric motors that doesn't take system losses into account.

Shaft power: A power rating used for combustion engines that doesn't take propeller losses into account, which can be anywhere from 20% to 75% of total power.

Propulsive power: The performance indicator used by commercial ships and by Torqueedo, which takes all losses into account and indicates actual power delivered.

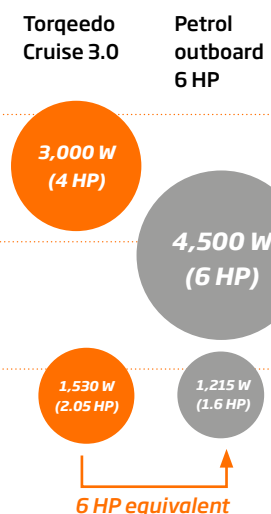

Convenience and value

What to expect when you switch to electric

Charging and handling are easy

An electric drive may simplify your onboard routines. Although charging batteries takes time, Torqeedo owners appreciate the simplicity of just plugging in at the end of the day – no need to find a fuel station or carry

cans of fuel down the dock. Owners of Travel or Ultralight systems can charge on board via a 12/24 V supply or the Sunfold 50 solar panel, or bring the lightweight, portable lithium battery home to charge it using the mains charger that is supplied. Cruise and Deep Blue-powered boats plug in to

shore power and charge overnight. Need a faster turnaround? The high-capacity batteries from these systems can also be equipped with fast chargers or multiple chargers.

Lightweight electric motors are also very easy to handle and store. Our best-selling Travel motors for dinghies, tenders and small sailboats start at just 15.5 kg, including the battery. Motor, battery and tiller also come apart so one piece can be handled at a time. They never leak or stink so your hands and your boat stay clean.

The economics of electric mobility on the water

In recreational boating today, cleaner and more convenient electric propulsion systems demand a price premium. Depending on the frequency of use, this may be offset by lower operating costs and lower maintenance and winterisation costs. Torqeedo offers full transparency on costs on its website. If you have any questions, please don't hesitate to contact us or your nearest Torqeedo dealer.

In commercial applications, electric mobility is often not only ecologically but also economically superior. Thanks to the substantially lower operating costs, electric propulsion systems often offer a lower total cost of ownership and help commercial operations improve their financial performance. Contact us to find out whether electric mobility will be economical for you.



Advanced engineering

No other electric boat motor manufacturer boasts such in-depth systems development, as many patents, or as much capacity for innovation as Torqeedo

Optimised components

A high-performance system requires high-performance components. Torqeedo employs in-house industrial engineering for all technologies required for electric mobility. All components are either developed by us or carefully selected to complete our systems.

A poorly designed propeller may only deliver 20% propeller efficiency, yet an outstanding one up to 75%. Torqeedo propellers are perfected over several thousand iterations



by the same methods as those used when developing propellers for commercial ships and submarines. But that is not all: the propeller needs to be matched to the motor gear and the requirements of the application, a process known

12%

of **Torqeedo's turnover** invested in research and development every year - a Silicon Valley level.

24,000

calculations per millisecond performed by the processor in the Torqeedo Travel 1103 motor. The computing power significantly improves motor response.

as drive train engineering. When combined with automotive-grade batteries and bespoke electronics and controls, you get superb building blocks for electric propulsion. But it's not a Torqeedo system yet.

We still have to achieve an intelligent interaction between the individual components and create a system that is safe, does its job and delights the user. Only then will we have created a true Torqeedo product. This systems-based approach is at the centre of everything we do.

Seamless integration

Our software engineers ensure that all the high-tech features of Torqeedo's motors, such as real-time range calculations, smartphone integrations, adaptive charging and battery safety protocols, work properly. Coding and testing can account for more than 50% of the development work for today's electric propulsion systems, depending on the system's complexity.

Torqeedo engineers develop data networks that allow different components to communicate with one another

quickly and seamlessly. The system constantly exchanges status messages, integrates sensor data and evaluates the appropriate course of action in a matter of milliseconds. Software stops the motor if it senses an impact to the propeller and manages battery charging safely. All Torqeedo motors, even the smallest kayak motors, have a GPS receiver built in that constantly measures speed over ground. With speed data combined with how much power the motor is using, the displays show real-time range and runtime estimates. When linked to a smartphone, the range remaining can even be displayed as a dynamic ring on a map. You never need to worry whether you have enough energy left to get home.

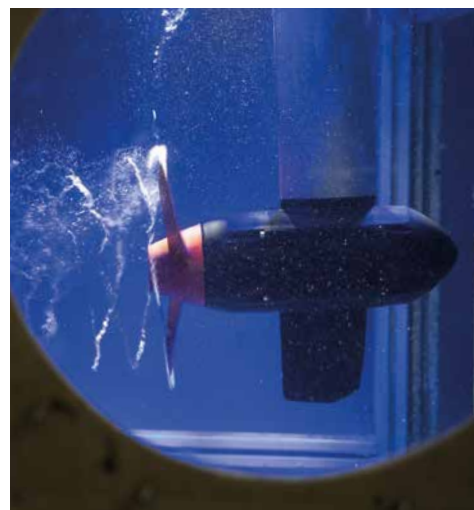

Propeller testing: a well-designed propeller may reach 75% efficiency, a critical step in optimising an electric drive train.

Prepared to drive the future

The most complex Torqeedo systems for large yachts or commercial applications simply wouldn't work without precisely manufactured components and painstakingly programmed software. With these bigger and more complex applications and as the world leader in marine electric drives, it is our responsibility to drive innovation and system development to the next level.

That's why we put so much effort into the development and preproduction process - from planning and design to final testing. Torqeedo's quality management system is ISO 9001-certified with DNV and our more than 250 international patents for electric boat-ing speak for themselves.

Besides rigorous endurance tests and electromagnetic compatibility testing, Torqeedo has 40 test benches just in our German headquarters outside Munich.

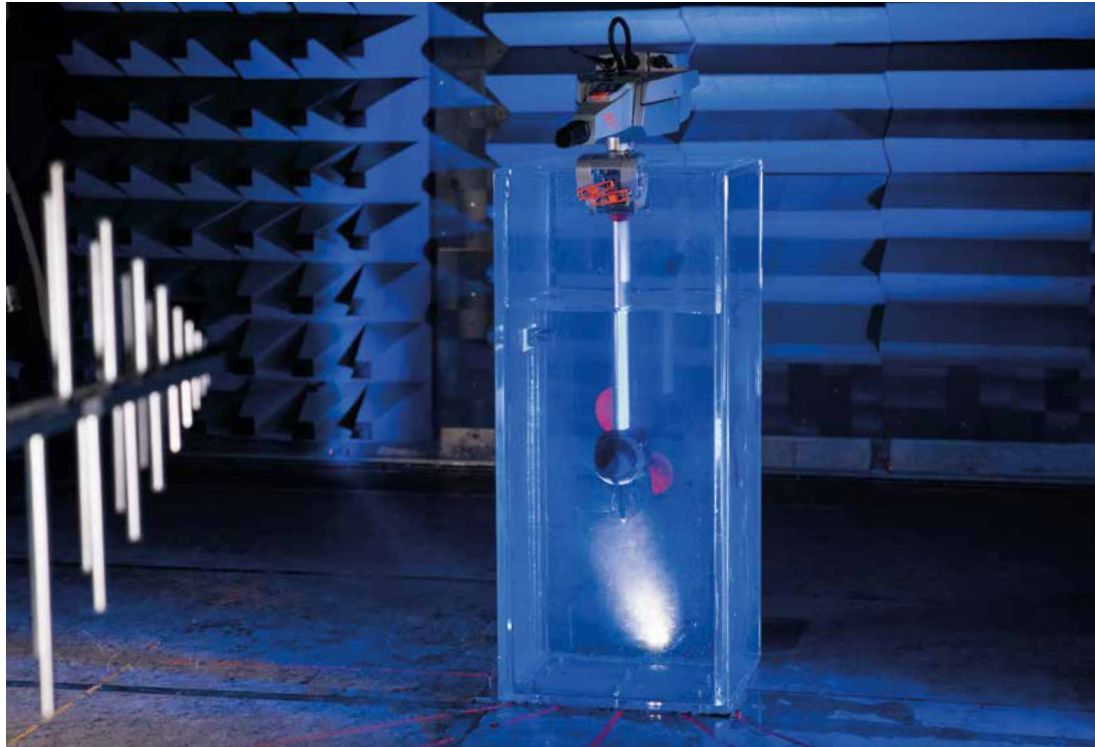

Torqeedo's EMC chamber: Measures electro-magnetic compatibility and ensures norm conformity and reliability.

These benches perform comprehensive and long-term testing, as well as specific tests for gaining additional product- and project-specific approvals, thus achieving or surpassing the highest quality standards in the maritime sector.

265

international and multinational patents held by Torqeedo and covering all components and systems of electric boat motors.

40

lab benches for endurance testing and certifying compliance with international standards located in the German Torqeedo headquarters alone.

PowerTree is a rapid charging system for marinas, commercial operations or remote areas. Charge the Power Tree with available power, solar, or other renewable energy, then use that power to fast-charge your Torqeedo-powered vessel.

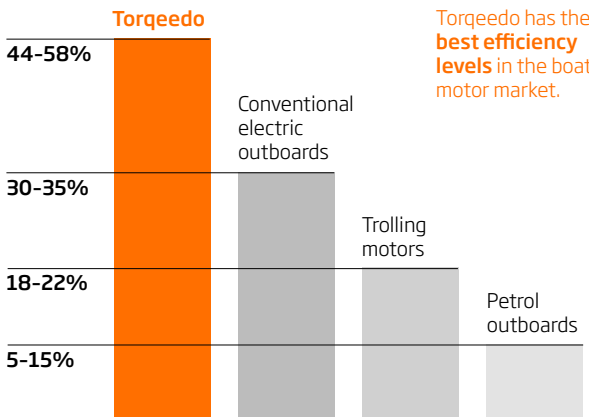

Torqeedo has the best efficiency levels in the boat motor market.

Overall efficiency levels of various outboards

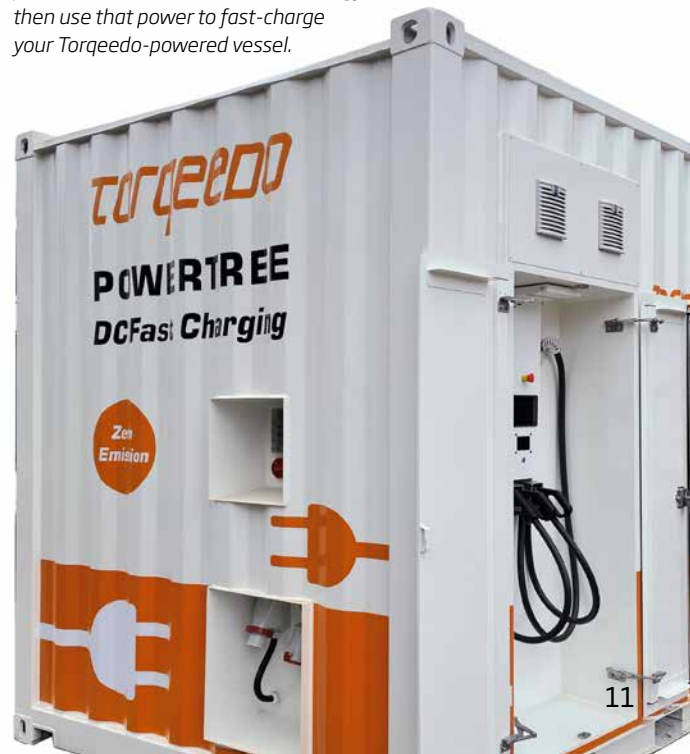

Ultralight



- + Range up to 53 km
- + Weight as low as 8.8 kg
- + Ultra-quiet direct drive (1103 AC)
- + Easy to mount on fishing kayaks
- + Superb usability with a wealth of smart features

Kayaks
Canoes
Very light boats

1 HP
equivalent

3 HP
equivalent

The Ultralight is the easy-to-mount solution for today's fishing kayaks.

Throttle

Battery

As tested on
an ATAK 140

Ultralight 403 AC

9.1 km/h - 2:10 hr
6.4 km/h - 8:45 hr
3.2 km/h - 45:40 hr

Ultralight 1103 AC

11.9 km/h - 0:50 hr
6.4 km/h - 8:04 hr
3.2 km/h - 45:40 hr



Ultra-powerful. The Ultralight 1103 AC

Professional kayak anglers don't hit the water without their Ultralight, and neither should you. With the Ultralight 1103 AC, you can beat the crowd and get to that coveted spot more than 30% faster. The whisper-quiet, direct-drive Ultralight 1103 AC comes with the innovative angler mount and all the high-tech features you've come to expect: GPS built in, real-time range and run-

time display, solar charging, superior safety and performance, and the latest lithium battery technology. The 1103 AC is almost three times more powerful than the Ultralight 403 for the ultimate in acceleration and pulling power, and adds instant throttle response for improved manoeuvrability and a heavy-duty construction with more resistance to impact damage.

A summary of the Ultralight accessories can be found on [page 42](#) or in the Ultralight section online at www.torqeedo.com/ultralight



ULTRALIGHT 1103 AC

ULTRALIGHT 403 A/AC

These well-known kayak brands have developed custom Ultralight mounts:





Raising, locking and parking the smart way

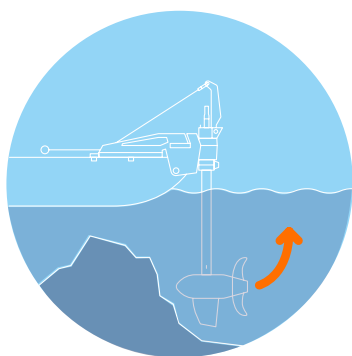

No problem with obstacles

The mount allows the motor to kick up toward the stern of the kayak when it encounters an underwater obstacle, thus minimising damage.

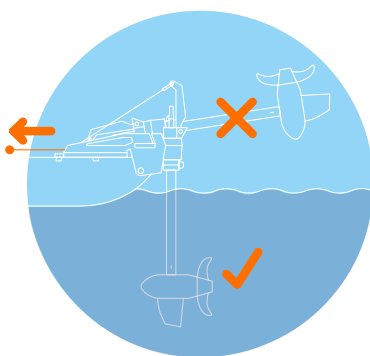

Reversing with one simple action

Pull the reverse cord and simply hold tension or secure it in the included cleat. Release the cord when moving forward to enable the automatic kick-up feature.

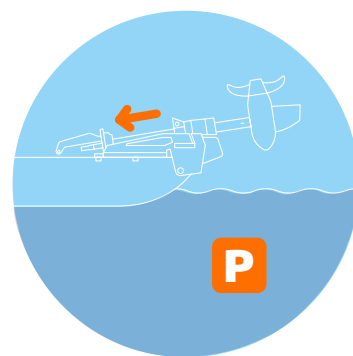

Handy park position

Safely stowing the Ultralight 403 for transport is quick and easy. Simply pull up and secure with the included elastic cord. To transport the Ultralight 1103, use the quick-release to remove the motor and stow.

High performance, speed and range

Dependent on factors such as type of boat, load, propeller and ambient conditions. Figures for speed and range are indicative only and are not a guarantee of performance.

As tested on an
ATAK 140

Ultralight 403 AC

9.1 km/h - 2:10 hr
6.4 km/h - 8:45 hr
3.2 km/h - 45:40 hr

Ultralight 1103 AC

11.9 km/h - 0:50 hr
6.4 km/h - 8:04 hr
3.2 km/h - 45:40 hr

Travel



- + Lightest outboards in their power class, from 15.5 to 17.3 kg complete
- + Highest overall efficiency
- + Quietest electric outboard
- + Most dynamic motor response
- + Onboard computer with GPS, remaining range, charge status and additional functions
- + Easy handling, fast battery swaps, simple to transport

Tenders
Dinghies
Daysailers

Travel 603: boats up to 1 ton
Travel 1103 C: boats up to 1.5 tons



The lightest and quietest small outboards on the market, Travel motors make motoring easy and carefree.



As tested on a one-class racing sailboat	Travel 603	Travel 1103
	7.1 km/h - 0:50 hr	8.2 km/h - 0:50 hr
	5.8 km/h - 1:50 hr	5.8 km/h - 3:20 hr
	3.0 km/h - 5:00 hr	3.0 km/h - 9:00 hr

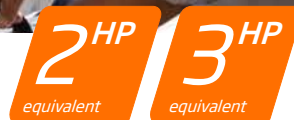

The freedom to Travel

Travel motors have been delighting boaters with their outstanding efficiency, useful technology and easy-to-use design for more than 16 years. The Travel 1103 and Travel 603 motors are the lightest, quietest outboards in their respective power classes and come with a high-performance lithium-ion battery and a built-in onboard computer with GPS, remaining range and charge status - everything you need to know at a glance. Travel

motors boast a durable direct-drive motor, industrially engineered to provide superior efficiency and the most dynamic motor response. The Travel 1103 comes with a high-capacity 915 Wh battery but is still easy to handle at just 17.3 kg complete. Racing yachts and other weight-sensitive applications may prefer the Travel 603 at just 15.5 kg, complete. Its 500 Wh, 4.2 kg battery even floats!



TRAVEL 603

TRAVEL 1103 C

What's inside your battery (and why it matters)



Battery cell type might be the most important factor when selecting an electric outboard. Travel batteries use high-quality, individually welded, cylindrical steel safety cells equipped with multiple safety mechanisms made by the world's most reputable manufacturers. The battery is further protected with a built-in battery management system with redundant hardware backups for every safety-relevant function. Other cell types, such as inexpensive pouch cells, are susceptible to damage from heat, vibration and the repeated shocks common on boats. Consumer-grade pouch cells also offer less effective protection against short-circuiting and have a shorter overall service life.





Motor accessories

Like all products from Torqeedo, Travel motors are offered with a full suite of high-tech accessories. It's easy to add a spare battery or a remote throttle for operating the motor from the helm instead of the tiller, or choose the TorqTrac smartphone app.

New for 2023, it's even easier to Travel on solar power! **The new solar charging cable** (part no. 1997-00) allows you to connect your battery to a third-party solar panel up to 160 W with a standard MC4 connection.



With the optional Bluetooth dongle installed, TorqTrac turns your compatible smartphone into a bright, easy-to-read onboard computer with a number of useful motor and battery readouts. The app is available from the App Store (iOS) or Google Play Store (Android).

See page 42 for the full range of accessories for your new Travel.



Double your range!

The high-capacity 915 Wh battery that comes with your new Travel 1103 offers plenty of power for most tenders, dinghies and daysailers.

For heavier vessels or more demanding use cases consider adding a second lithium battery.



No more leaky, smelly petrol tanks - switching to a freshly charged battery takes seconds and you're back underway!

High performance, speed and range

Dependent on factors such as type of boat, load, propeller and ambient conditions. Figures for speed and range are indicative only and are not a guarantee of performance.

As tested on a one-class racing sailboat

	Travel 603	Travel 1103
	7.1 km/h - 0:50 hr	8.2 km/h - 0:50 hr
	5.8 km/h - 1:50 hr	5.8 km/h - 3:20 hr
	3.0 km/h - 5:00 hr	3.0 km/h - 9:00 hr

As tested on a fishing boat

	Travel 603	Travel 1103
	7.9 km/h - 0:55 hr	9.3 km/h - 0:50 hr
	6.1 km/h - 1:45 hr	6.9 km/h - 2:17 hr
	3.9 km/h - 5:20 hr	3.9 km/h - 9:10 hr



Cruise Outboards



- + Minimum weight with maximum performance
- + Onboard computer with GPS
- + Durable and extremely robust design
- + Effective corrosion protection for fresh and salt water
- + Extended range thanks to very high energy density batteries

As tested on
Linder 400
Sportsman

Cruise 6.0 R

27.0 km/h - 0:50 hr

13.0 km/h - 1:40 hr

8.5 km/h - 5:00 hr

with 1 x
Power 48-5000

Motorboats, dinghies, sailboats,
water taxis, passenger ferries
and commercial applications up to 12 tons



The ultimate power packs
for sailing or motorboats.

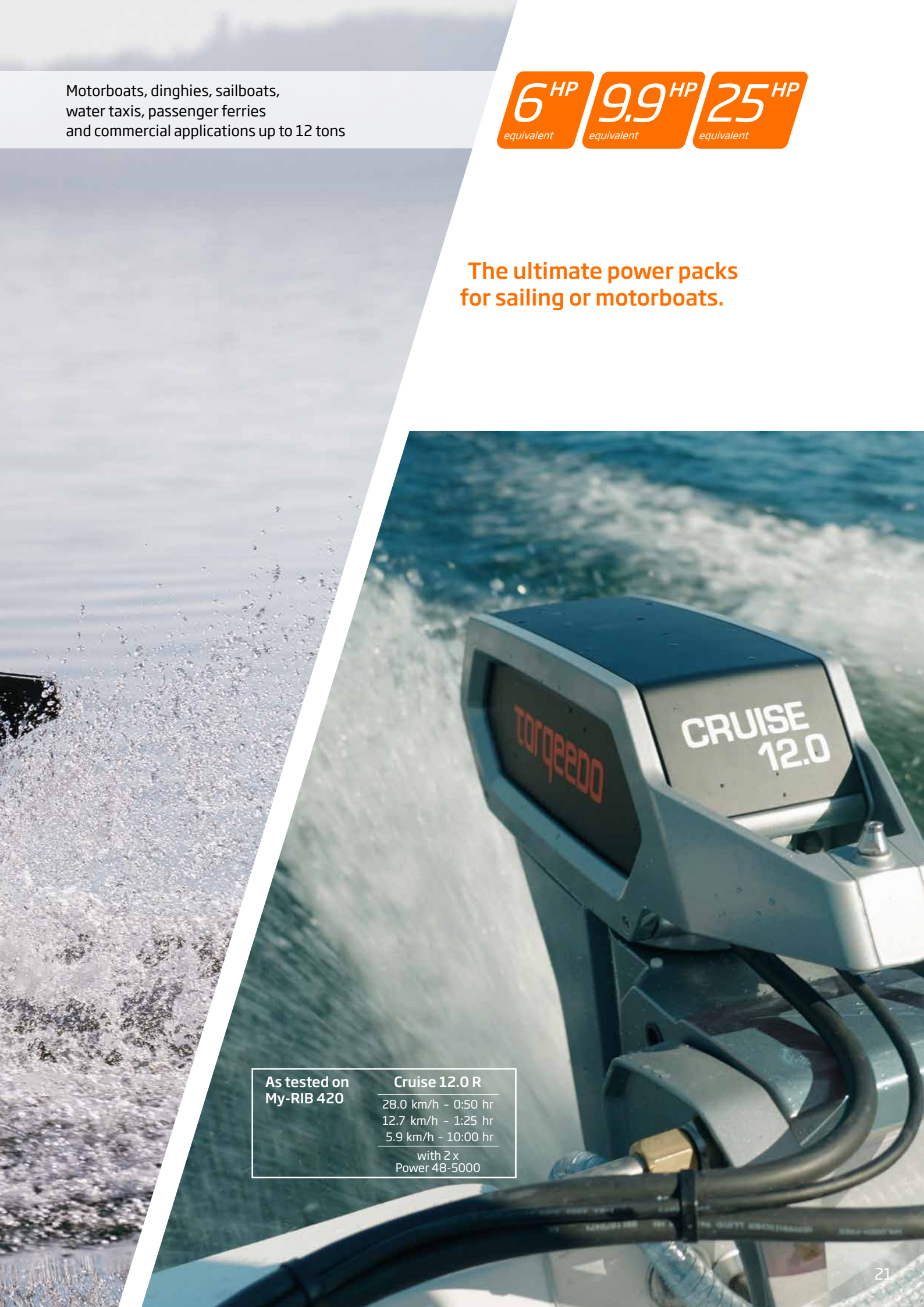

As tested on My-RIB 420	Cruise 12.0 R
	28.0 km/h - 0:50 hr
	12.7 km/h - 1:25 hr
	5.9 km/h - 10:00 hr
	with 2 x Power 48-5000



The perfect way to Cruise

Since their premiere in 2006, Cruise motors have been the electric outboard motor of choice for motorboats, dinghies and commercial users. Powerful and easy to use, all Cruise systems have a built-in GPS with onboard computer and display with speed and input power, state of charge and remaining range.

Cruise 3.0 is a 24 V, 6 HP-equivalent outboard perfect for boats up to 3 tons. With a single Power 24-3500 lithium battery, this lightweight and

budget-friendly e-drive gives you up to one hour of full-throttle runtime and runs all day at slower speeds. Need more range or speed? You can add up to 16 Power 24-3500 batteries for more energy storage. Choose from remote-steered with a standard top-mount throttle (1918-00) or a tiller model.

The Cruise 6.0 R and 12.0 R are 48 V systems powered by Torqeedo's Power 48-5000 lithium batteries. These powerful drives and batteries ship

with Torqeedo's advanced communication system, TorqLink, which allows faster and more accurate data sharing between system components. You can choose from either remote steering or tiller-equipped Cruise 6.0 outboards, which are 9.9 HP-equivalents for boats up to 6 tons. Cruise 12.0 is a 25 HP-equivalent outboard with remote steering for boats up to 12 tons. Cruise 6.0 R and 12.0 are compatible with a wide variety of TorqLink throttles.

A summary of the Cruise accessories can be found starting on [page 42](#) or online at www.torqeedo.com.



CRUISE 3.0 T/R



CRUISE 6.0 T/R*



CRUISE 12.0 R

* also available without TorqLink for Power 24-3500 integration



Let's do this

Ready to build the perfect Cruise drive system for your boat? Visit our online Cruise configurator, make your motor,

battery, throttle and charging selections and see what it will take to make your electric dream come true.

Scan me

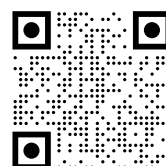

TorqLink throttle with colour display

With its bright, easy-to-read colour display, this throttle is the perfect control for your TorqLink-equipped Cruise 6.0/12.0 systems. It displays all critical system data at the push of a button

and boasts infinitely variable forward and reverse in a high-tech design. And it has Bluetooth built in for easy connection with TorqTrac, the Torqeedo smartphone app.



High performance, speed and range

Dependent on factors such as type of boat, load, propeller and ambient conditions. Figures for speed and range are indicative only and are not a guarantee of performance.

As tested on
Linder 400
Sportsman

Cruise 6.0 R

27.0 km/h - 0:50 hr
13.0 km/h - 1:40 hr
8.5 km/h - 5:00 hr

with 1 x
Power 48-5000

As tested on
My-RIB 420

Cruise 12.0 R

28.0 km/h - 0:50 hr
12.7 km/h - 1:25 hr
5.9 km/h - 10:00 hr

with 2 x
Power 48-5000



Cruise 6.0 for restricted waterways

This reduced-power version of our Cruise 6.0 delivers 4.3 kW at the prop shaft, which lets you access waterways with stricter boating license or horsepower restrictions. Contact your dealer for details.



Cruise Pod drives

- + Smaller and lighter than combustion saildrives
- + Virtually silent while in use
- + No fuel or oil to leak or stink
- + Powerful lithium batteries provide long-range motoring
- + Minimal impact on sailing speed
- + Durable design and excellent corrosion protection for fresh and salt water

As tested on a
daysailer

Cruise 3.0 FP

11.0 km/h - 1:10 hr
8.5 km/h - 3:00 hr
6.5 km/h - 9:00 hr

with 1 x
Power24-3500

Cruise 6.0 FP

13.0 km/h - 0:50 hr
10.0 km/h - 3:00 hr
7.0 km/h - 9:00 hr

with 1 x
Power 48-5000

Sailboats up to 12 tonnes
Commercial application up to 12 tonnes

6^{HP}
equivalent

9.9^{HP}
equivalent

25^{HP}
equivalent

**Quiet and eco-friendly, lightweight
Cruise pods free up space below
deck and can charge their own
batteries while under sail.**





Peace and power

Don't confuse silence with weakness.

Torqeedo's Cruise fixed pod lineup is powerful, lightweight, efficient and saves space onboard. The flagship model, the Cruise 12.0, is a 25 HP-equivalent that easily powers sailboats up to 12 tons. All Cruise motors come with an onboard computer and display with GPS-calculated range and runtime.

Cruise 6.0 and 12.0 pods come standard with Torqeedo's advanced communication system, TorqLink, which allows faster and more accurate data sharing between system components.

Visit our online Cruise configurator to build your perfect pod system. Scan QR Code.

Scan me

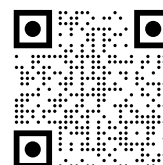

A summary of the Cruise accessories can be found on [page 42](#) or online at www.torqeedo.com.



CRUISE 3.0 FP



CRUISE 6.0 FP



CRUISE 12.0 FP



Free for all

Generate emission-free, noise-free and cost-free energy while sailing? Yes, please! Cruise Fixed Pods can charge their own batteries while underway, so you always have plenty of power on board.

Hydrogeneration Cruise 12.0 FP

Values were determined in a towing test and represent the expected possible performance. Speed was measured by speed over ground (GPS). Actual approach speed at the propeller (speed through water) can deviate considerably and lead to significantly different performance.

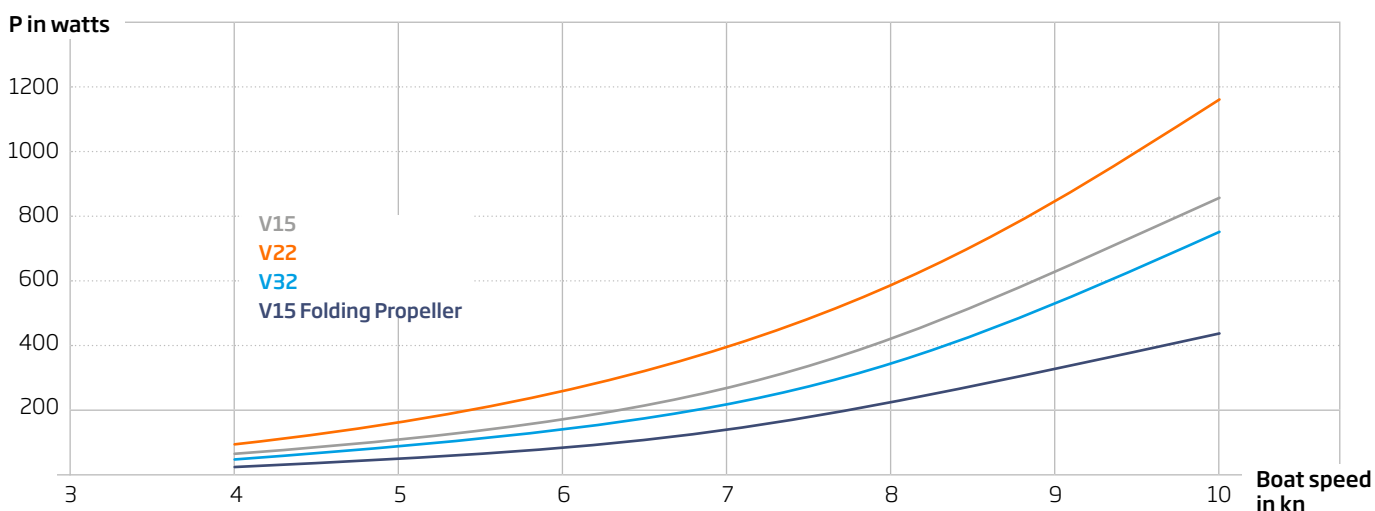

High performance, speed and range

Dependent on factors such as type of boat, load, propeller and ambient conditions. Figures for speed and range are indicative only and are not a guarantee of performance.

As tested on a daysailer

	Cruise 3.0 FP	Cruise 6.0 FP
	11.0 km/h - 1:10 hr	13.0 km/h - 0:50 hr
	8.5 km/h - 3:00 hr	10.0 km/h - 3:00 hr
	6.5 km/h - 9:00 hr	7.0 km/h - 9:00 hr
	with 1x Power24-3500	with 1x Power 48-5000



Cruise 6.0 for restricted waterways

This reduced-power version of our Cruise 6.0 delivers 4.3 kW at the prop shaft, which lets you access waterways with stricter boating license or horsepower restrictions. Contact your dealer for details.

Superior battery technology

Safe, powerful and easy to use, Power batteries are the ultimate energy source for Cruise motors and hotel loads

Lithium-ion batteries are the technology of choice for electric mobility applications. They store significantly more energy than other batteries, maintain a high current (a major advantage for electric drive systems), do not lose their charging capacity, supply power reliably even in cold weather and have no memory effect. They also provide many more cycles than lead-based batteries.

Torqueedo has been a pioneer in the development of lithium batteries for marine applications for more than a decade. Since we make our batteries just a little bit better each year, we offer the most comprehensive and integrated protection and safety concept for lithium batteries on the market – coupled with performance and convenience.



Intelligent battery management system (BMS)

The BMS **monitors and protects** Torqeedo batteries against overcharging, overcurrent, deep discharge, short-circuiting and overheating. The battery has comprehensive safety features, and each safety-relevant component is duplicated with a backup component should it fail. In addition to these safety features, the BMS safeguards the battery's life expectancy with balancing and deep-sleep functionality.

Safe and easy to transport

Thanks to their **high energy density**, the volume and weight of lithium batteries are more than 70% lower than comparable AGM or lead-gel batteries. This makes our low-voltage batteries simple to handle and light to carry. On top of that, Torqeedo Power and Deep Blue batteries can be switched on and off, allowing them to be safely **transported and installed** and protecting them against unintentional discharge.

Safety of lithium batteries

Besides performance, safety plays an important role for lithium batteries. In our view, four factors need to be considered in order to ensure that safe really means safe:



Battery management system (BMS) with redundant safety features:

Unlike lead-based batteries, lithium batteries always need a BMS to perform balancing and safety functions. If any electronic components of the BMS fail, it may itself become a safety risk for the battery. That's why there is hardware backup for all safety-relevant components in Torqeedo batteries. Incidentally, this is also stipulated in the automotive and aerospace industries and for medical technology.

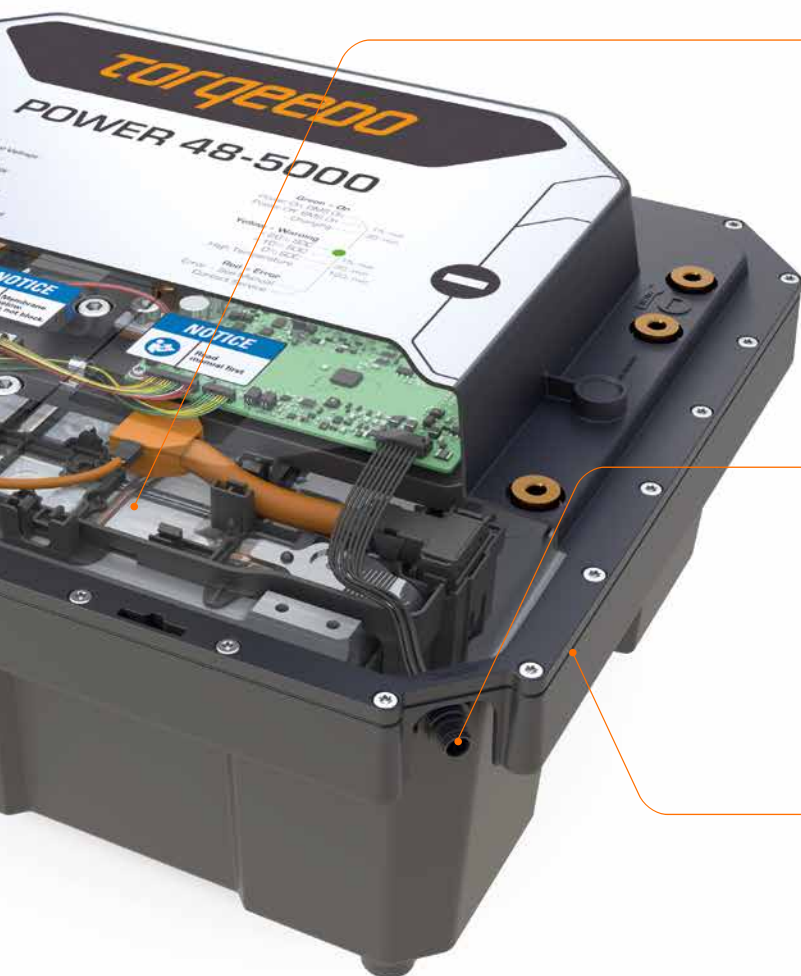

High-quality safety cells

Several hardware mechanisms in every single cell provide additional safety. Torqeedo only uses cells based on lithium sourced from the **clean, precision production processes** of reputable manufacturers.

System communications

The battery electronics continuously communicates all the details of the battery status to the onboard computer.

Completely waterproof

Waterproof housing (IP67): While battery immersion should be avoided, all Torqeedo batteries are, without exception, completely waterproof. The waterproof characteristics of each battery are individually tested prior to delivery.

Waterproof connections: Whether connected or not, all cable connectors are completely waterproof to IP67.



Safe cell packaging: Torqeedo only uses individually welded safety cells - either steel cylindrical or assembled into modules and equipped with multiple safety mechanisms. Other forms of packaging offer a lower standard of safety as they afford less effective protection against short-circuiting within the cells.



Clean, precision production processes on the part of the cell manufacturers: Torqeedo only uses cells and modules sourced from the world's most reputable brands.



Waterproof to IP67: Water in lithium batteries can lead to various problems, such as corrosion of the BMS hardware or generation of electrolytic gas. Lithium batteries on board a boat should therefore be waterproof.

Power play

The 24 V Power 24-3500 delivers 3.5 kWh of power in just 25.3 kg for an impressive energy density of 138 Wh/kg. With the 1,700 W fast charger, you can fill up the Power 24-3500 in just under two hours, making this lithium pack perfect for the Cruise 3.0 motor or powering hotel loads on board. For boats powered by Cruise 6.0, 10.0 or 12.0 motors, choose the 48 V Power 48-5000 with TorqLink.



POWER 48-5000



POWER 24-3500



Technical data	Power 48-5000	Power 24-3500
Useable energy	5,000 Wh	3,500 Wh
Nominal energy	5,275 Wh	3,679 Wh
Nominal voltage	44.4 V	25.6 V
Weight	36.5 kg	25.3 kg
Energy density (weight)	135 Wh/kg	145 Wh/kg
Maximum discharge rate	200 A (8,880 W at nominal voltage)	180 A (4,500 W at nominal voltage)
Dimensions	506 x 386 x 224 mm	577.5 x 218.5 x 253.5 mm
Battery chemistry	LMO-NMC	Li-NCA
Cycle lifetime	> 3,000 cycles at 80% depth of discharge at 25°C results in approx. 20% capacity loss	800 cycles at 100% depth of discharge at 25 °C results in approx. 25% capacity loss
Annual capacity loss	< 3%	< 4%
Max. connections	2P as shipped; up to 8P with Torqeedo support	2S8P or 1S16P
TorqLink	Yes	No
Price-performance	1 EUR/Wh	0.86 EUR/Wh

Head for the horizon with Cruise Hybrid

Cruise Hybrid systems provide economical, complete power for your 25- to 40-foot vessel up to 12 tons. Tried-and-tested Cruise motors are matched with high-performance lithium-ion batteries from Torqeedo's Power series, a variety of charging options and electronic throttles and displays - all connected with TorqLink, Torqeedo's advanced communications protocol. Choose to view system data on your boat's NMEA 2000 multi-functional display, throttle display or directly on your smartphone with the TorqTrac app.

Charge your batteries from shore power with our standard or fast chargers, or harness the power of the sun with a smart solar charge controller and your onboard photovoltaics. Sailboats can even charge their own batteries while sailing by simply placing the system in hydrogeneration mode. For seamless backup power you can integrate AC digital inverter generators up to 10 kW - just visit torqeedo.com for technical details.

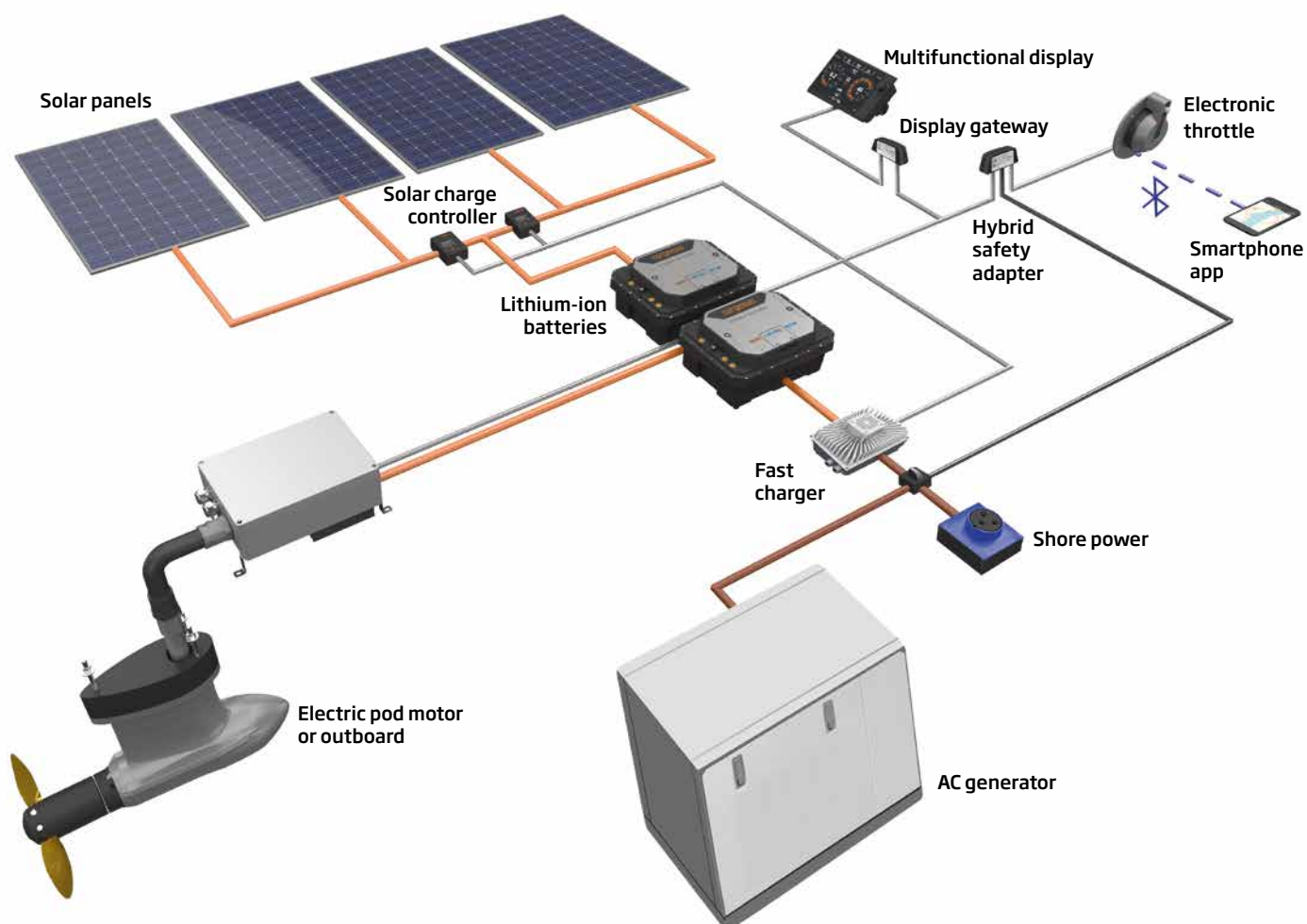

Deep Blue

- ✦ Deep Blue is the electric drive system of choice for the world's most reputable boat brands
- ✦ Motors up to 100 kW are available in a high-RPM version for planing boats and low-RPM for displacement vessels
- ✦ 40 kWh batteries deliver the latest in automotive technology adapted for marine use
- ✦ Sets industry standards for production quality and safety systems
- ✦ Clean, renewable energy generation and optional generator integration

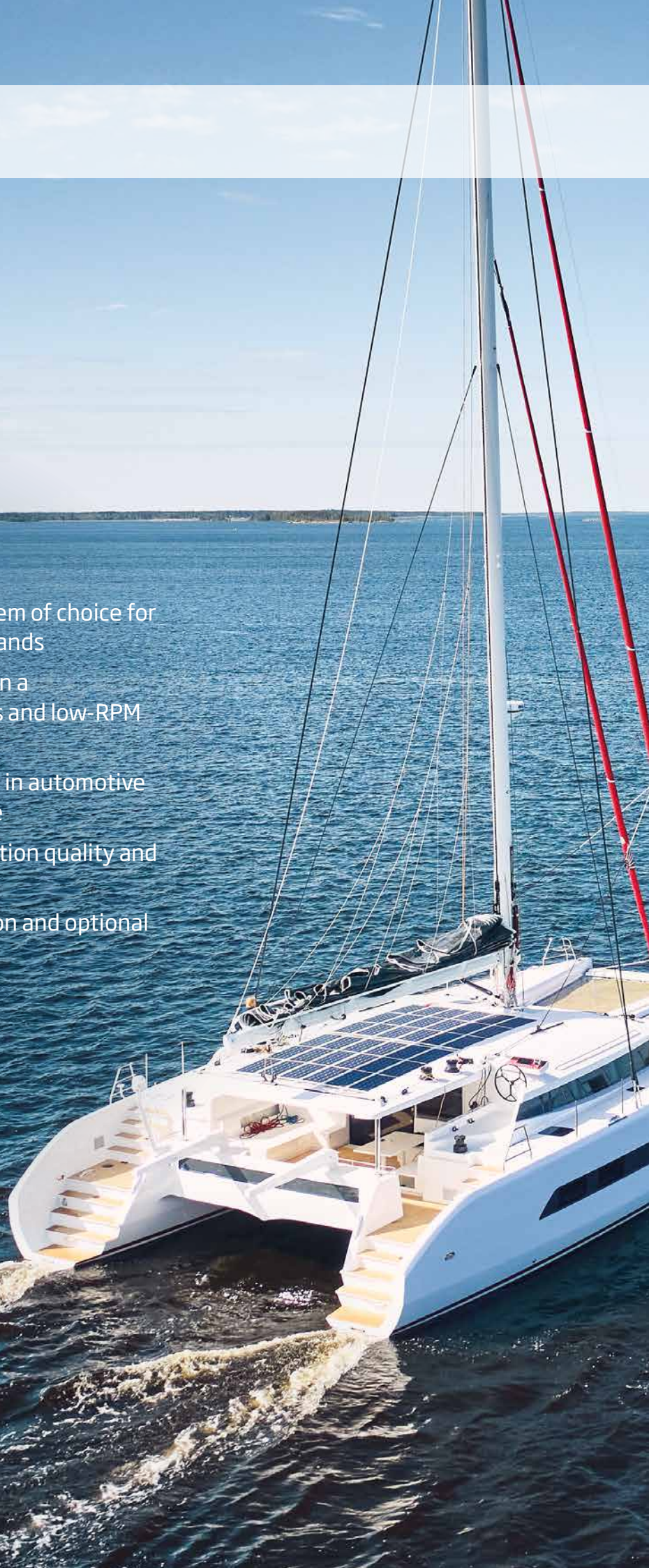

Yachts up to 120 feet
Large motorboats
New build or refit

Boats for commercial use,
e.g. water taxis, ferries and
tour boats

25^{kw}

50^{kw}

100^{kw}

The only complete solution for
powerful electric drive systems
available on the market today -
a fully integrated propulsion and
energy management system.



The modular, scalable, single-source solution

More than just a battery-powered electric motor, Deep Blue is a fully integrated propulsion and energy management system - customisable with modular components and industrially engineered to meet the highest demands. The result is exceptional

performance and safety, compliance with international standards at the system level and highly intuitive operation. This single-source turnkey solution is available as an outboard, inboard or saildrive for recreational boats and commercial applications.

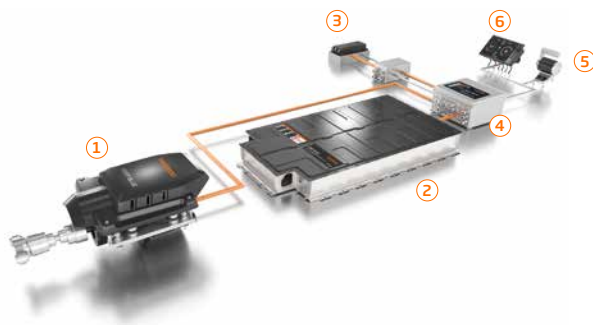

- 1 Powerful electric motor
- 2 360 V high-capacity lithium battery system
- 3 Shore power chargers
- 4 System management unit
- 5 Electronic throttle
- 6 Display with onboard computer

Deep Blue system

The essential Deep Blue configuration is suitable for vessels with access to shore charging and a priority on propulsive power. The system components, from propeller to high-tech user interface, are perfectly matched and integrated to provide emission-free, quiet and powerful propulsion.

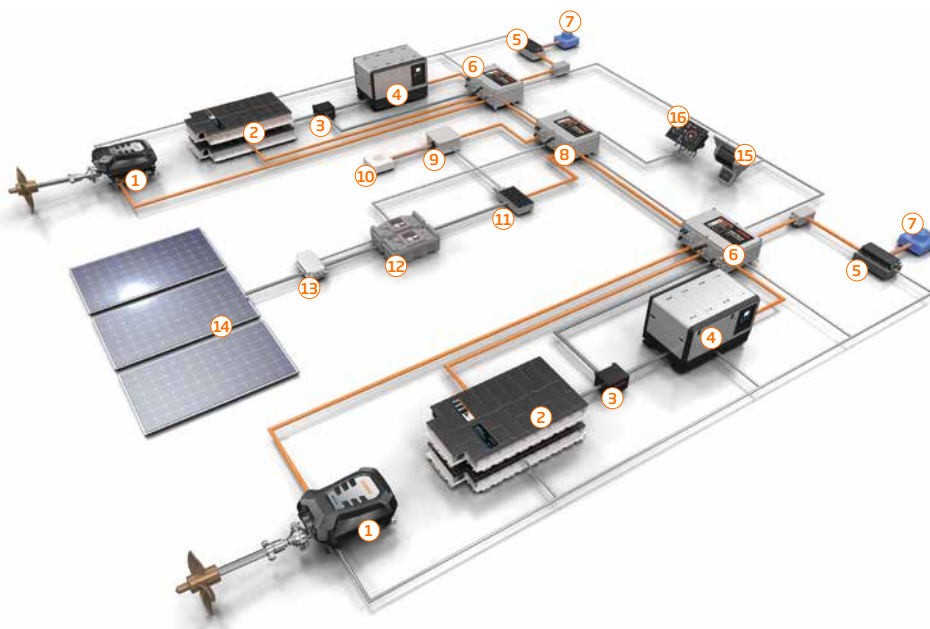

- 1 Powerful electric motor
- 2 360 V high-capacity lithium battery system
- 3 12 V batteries
- 4 Efficient state-of-the-art diesel generator
- 5 Shore power chargers
- 6 System management unit
- 7 Shore power connection
- 8 System connection box
- 9 AC inverter
- 10 Isolated AC power system (120/240 V AC current, 50/60 Hz)
- 11 Bi-directional DC/DC converter
- 12 24 V onboard batteries
- 13 Solar charge controller
- 14 Photovoltaic modules
- 15 Electronic throttle
- 16 Display with onboard computer

Deep Blue Hybrid system

This integrated, modular system is suitable for larger vessels, oceangoing yachts or commercial vessels with complex onboard energy requirements. Deep Blue Hybrid provides comprehensive energy management. Each component's energy demands are monitored and managed by the central system, ensuring economical collection and distribution of clean, renewable energy with automatic generator backup when necessary.

Always in control

Deep Blue offers intuitive operation presented on the multifunctional display, providing a complete overview of the entire system and access to all control functions.

The software keeps an eye on everything and prevents issues like deep-discharging batteries. An easy-to-understand graphical user interface is available as either multihull or monohull and delivers complete, up-to-the-minute system visualisation.



Main menu: Navigate easily between different categories.



Drive screen: All important information needed while motoring or sailing. You can choose to display or hide the information line at the top.



System management: Provides status data on all system components. Select individual components for more detail.

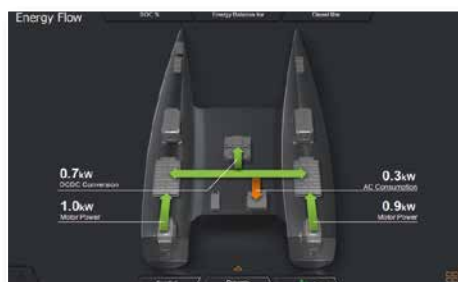

Energy flow: Understand your system's power balance and energy flow at a glance.





Deep Blue for sailboats

When designing a new sailing yacht or contemplating a refit, each component must be evaluated to be sure it does its job, works well with the rest of the on-board systems and provides the best possible user experience. Deep Blue and Deep Blue Hybrid, with powerful

electric motors available up to 100 kW, make yachting more convenient and more environmentally friendly, while reducing dependence on shore supplies through onboard generation of clean, renewable power. Add in worldwide service, a 9-year limited

battery warranty (for recreational use) and the peace of mind that comes with choosing the world leader in electric mobility on the water and this choice couldn't be clearer.



DEEP BLUE 25 SD



DEEP BLUE 50 SD



DEEP BLUE 25/50 i



DEEP BLUE 100 i 900

TECHNICAL DATA

SAILDRIVES

INBOARDS

	Deep Blue 25 SD	Deep Blue 50 SD	Deep Blue 25 i 1200	Deep Blue 50 i 1200	Deep Blue 100 i 900
Max. propeller speed	1,360 rpm	1,325 rpm	1,200 rpm	1,200 rpm	900 rpm
Shaft power (continuous)	25 kW	50 kW	25 kW	50 kW	100 kW
Shaft power (peak)	-	-	-	57 kW	-
Torque (continuous)	176 Nm	426 Nm	272 Nm	400 Nm	1060 Nm
Torque (peak)	-	-	-	468 Nm	-
Weight (incl. electronics)	125 kg	180 kg	88 kg	88 kg	475 kg



Deep Blue for motorboats

The first and only high-power electric drive system for motorboats from industrial production, Deep Blue offers exceptional performance, professional safety and easy operation. Motorboats and fast yacht tenders can choose

from our high-tech outboard and in-board drives paired with high-capacity lithium batteries. The 40 kWh battery is the ultimate standalone energy source.

With a 9-year limited battery capacity warranty (for recreational use), outstanding efficiency and a proven long service life, Deep Blue is the exclusive solution for powerful electric motorboats.



DEEP BLUE 25/50 R



DEEP BLUE 25/50 i



DEEP BLUE 100 i 2500

TECHNICAL DATA

	OUTBOARDS		INBOARDS		
	Deep Blue 25 R	Deep Blue 50 R	Deep Blue 25 i 2000	Deep Blue 50 i 2000	Deep Blue 100 i 2500
Max. propeller speed	2,440 rpm	2,440 rpm	2,000 rpm	2,000 rpm	2,700 rpm
Shaft power (continuous)	25 kW	49 kW	25 kW	50 kW	100 kW
Shaft power (peak)	-	55 kW	-	57 kW	120 kW
Torque (continuous)	129 Nm	190 Nm	164 Nm	240 Nm	385 Nm
Torque (peak)	-	215 Nm	-	281 Nm	430 Nm
Weight (incl. electronics)	from 139 kg	from 139 kg	88 kg	88 kg	200 kg

The power of Deep Blue

High-capacity lithium batteries with proven automotive technology, superb energy density and the highest safety standards

The latest generation of automotive battery cells:

- Very high energy density
- Prismatic cell design allows efficient cooling, a compact form, even temperature distribution within the battery and an extremely rugged structure
- Robust protective aluminium housing with safety vent
- From the automated production process of Samsung SDI, a leading manufacturer of lithium battery cells

Laser-welded cell connections:

Over a larger surface and therefore stronger and more powerful than conventional spot-welded cell connections.

Pressure safety disc: The battery is waterproof to IP67.

In the unlikely event of excess pressure developing in a cell, the prismatic cells will release the excess pressure through a valve. This is a significant safety advantage over foil-welded cells and pouch cells. The pressure safety disc allows gases to escape and ensures the battery stays waterproof in normal operation.

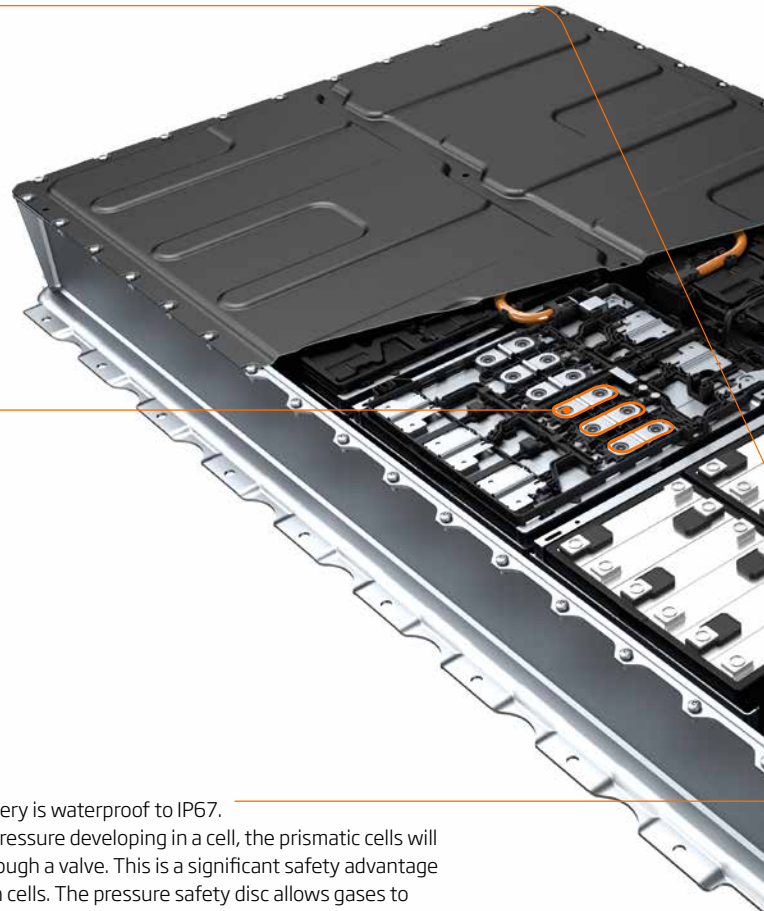

Professional safety standards



The **insulation monitor** constantly monitors that the voltage from all 360 V components is completely isolated from the boat - not just for individual system components but for all of them. If damage is detected, e.g. to the cable insulation, the system will issue an alert.



Automotive industry-level battery safety: The first lithium batteries for the marine industry with the advanced quality standards of the automotive sector are the result of Torqeedo's collaboration with established battery manufacturers. Integrating a battery into a drive system and the associated safety concept alone requires considerable effort that can only be achieved by working together with the battery manufacturer.

Scan me

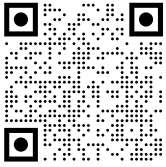

Deep Blue batteries are available with DNV type approval for commercial use.

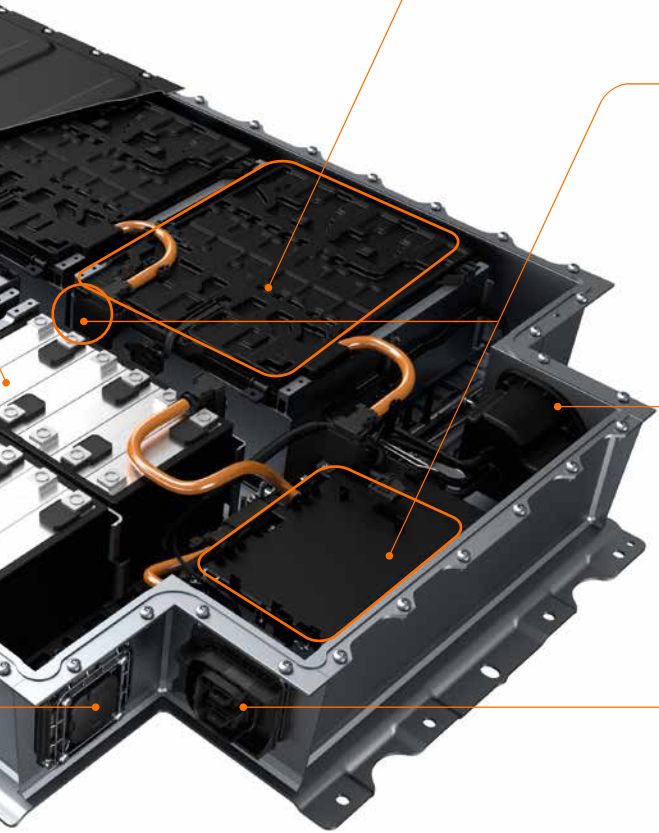

Automated module production:

- Prismatic cells have many advantages. However, they must be assembled extremely accurately in a very robust frame for a long service life. Otherwise, charging and discharging would lead to the cells very slightly expanding and contracting and cause them to age prematurely over time.
- The very rugged design is ideal for boat applications that place high demands on shock resistance.

Battery management system (BMS) at module and battery levels:

- State-of-the-art BMS technology
- Developed to ASIL C standards as used in the automotive industry for maximum safety
- Qualification and acceptance testing at a far higher level than is typical in the boating industry

Compressor cooling: Cools the battery to ensure high performance and a long service life, even in high ambient and water temperatures - in all climate zones anywhere in the world.

Power and data connections from the battery to the Deep Blue system

IP67

All components are waterproof:

Components that were not specifically developed for boats are not always waterproof. All the components of a high-power system on a boat must be waterproof to guarantee safe operation. That is why all of our components are waterproofed and, in some cases, are further protected by water sensors.



Battery venting: In the unlikely event that the redundant safety mechanisms of the battery fail, the battery cells can reduce their temperature and pressure via a pressure valve. While batteries are installed in electric cars in such a way that they can discharge battery gases directly onto the road, on electric boats the gases must be channelled safely off the vessel. We developed the first safe venting system for boats for the Deep Blue system.



Battery damping: All components on fast and seagoing boats are subject to constant high levels of shock that exceed shock levels on the road - in some cases over 12 g of acceleration force. The same holds true when trailering the boat. Since batteries and battery electronics are not designed for these constant impacts, they need their own damping system on boats (in addition to the damping mechanisms within the battery). Torqeedo was the first industrial-scale manufacturer to provide this for maritime use.

The perfect powerhouse

Deep Blue Battery 40

The latest battery technology from the automotive industry: high energy density, long service life, robust and built to the highest standards of quality and safety. With 40 kWh of capacity, the Deep Blue battery provides plenty of power for a full day on the water and paves the way for all sorts of new Deep Blue applications. The Deep Blue battery is available with DNV type approval for commercial use and with an optional cooling system.



Technical data

Nominal voltage	352 V
Chemistry	Lithium-Ion, NMC
Safety	IP67 ingress protection, venting, damping, IEC 62619 & IEC 62620
Capacity (usable)	38 kWh
Weight	284 kg
Dimensions	1666 x 993 x 173 mm

Deep Blue 22 kW AC Charger

Liquid-cooled battery charger converts shore power to DC voltage for fast, efficient battery charging. Also allows you to charge your system via onboard AC generators.



Technical data

Input power	22 kW
Typical efficiency	95%
Waterproof	IP67, IP6K9K
Weight	19 kg (charger), 10.5 kg (AC box)
Dimensions	705 x 106 x 359 mm

Integrate a range extender

Automatic and efficient backup power

Deep Blue's DC interface makes it easy to manage your DC range extender for seamless, convenient and ultra-efficient backup power. The system automatically makes sure the generator is always working at its most efficient point, minimising runtime and reducing fuel consumption, noise and vibration. Check on your energy balance at a glance, set charging parameters, maintain state of charge or explore ultra-convenient options like Night Mode, which ensures batteries are fully charged by the time you specify. This allows you to enjoy all the comforts of your yacht at night without running the generators.

Deep Blue DC interface

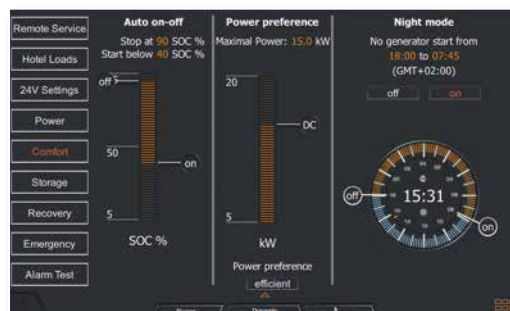

E power



SHORE IN 230-400VAC



CE
LIFE-2

Accessories

- + Add a spare battery for additional range
- + Charge via solar, 12 or 24 V onboard supply or plug in to shore power
- + Upgrade to a practical, ergonomic and Bluetooth-equipped throttle
- + Efficient propellers for high speed or more thrust





The full range of Torqeedo accessories is available at www.torqeedo.com

From bag sets to batteries, enhance your boating experience with Torqeedo accessories.

**TRAVEL
1103**



Controls



Aluminium throttles with TorqLink

Our aluminium throttles offer the right solution for every application with top mount, side mount and twin controls. Or, choose the budget-friendly TorqLink throttle with colour display. All TorqLink throttles come with Bluetooth built in for simple integration of Torqeedo's TorqTrac smartphone app.



Remote throttle

Instead of using the tiller, you can control your Travel or Cruise 3.0 motor with the throttle located 1.5 or 5 metres away. This remote throttle comes with an onboard computer display, fully variable forward and reverse, and two different lengths of data cable.



TorqLink throttle with colour display

With its bright, easy-to-read colour display, this throttle is the perfect control for your TorqLink-equipped Cruise 6.0 and Cruise 12.0 systems. It displays all critical system data at the push of a button and has Bluetooth built in.



Display gateway

Link external devices to Torqeedo drive systems with TorqLink. The small gateway plugs in quickly and easily, and allows NMEA-2000 devices to access and display key motor and battery information.

Power supply

Spare Ultralight batteries

Extend your range with a second battery on board. Available in 320 Wh or 915 Wh capacity.



Spare Travel batteries

Extend your range with a second battery on board. Available in 500 Wh or 915 Wh capacity.



Power 24-3500

This 25 kg 24 V lithium pack is perfect for the Cruise 3.0 motor or powering hotel loads on board.



Power 48-5000

For boats powered by Cruise 6.0, 10.0 or 12.0 motors, choose the 48 V Power 48-5000. Now with TorqLink, fast charging and solar charging.





Charging

Sunfold 50

This lightweight solar panel delivers lots of clean solar energy and can be easily folded for storage. Suitable for all Travel and Ultralight batteries from 2015.



Solar charge controllers

The integrated MPPT controls solar charging, maximising energy yield and overall efficiency for systems with Power batteries.



Fast chargers

Specifically developed for Power batteries, these fast chargers can fully charge a single battery in approximately three hours at 240 V.



USB adapter for Travel and Ultralight batteries

Charges small equipment such as smart-phones, cameras or onboard lights.



Propellers

Spare propeller

Choose a spare standard prop or a version with higher top-end speed or more thrust at low RPM.



Folding propellers for Cruise 3.0/6.0/12.0 FP

Low drag when under sail, powerful propulsion while motoring.



Propeller v22/p10k Cruise 10.0/12.0

For all Cruise 10.0 and 12.0 models. Medium-speed propeller for planing and displacement.



You can find more information about accessories and a detailed propeller guide on our website: www.torqeedo.com

Outboards and pods ≤ 25 HP equivalent

	ULTRALIGHT 403 A/AC	ULTRALIGHT 1103 AC	TRAVEL 603	TRAVEL 1103 C	CRUISE 3.0 T/R
Input power in W	400	1,100	600	1,100	3,000
Propulsive power in W	180	540	295	540	1,530
Comparable petrol outboard (shaft power)	1 HP	3 HP	2 HP	3 HP	6 HP
Comparable petrol outboard (thrust)	2 HP	4 HP	2 HP	4 HP	8 HP
Comparable diesel inboard (shaft power)	-	-	-	-	-
Comparable diesel inboard (thrust)	-	-	-	-	-
Maximum overall efficiency in %	45	49	49	49	51
Static thrust in lbs*	33	70	44	70	142
Integrated battery (Li-Ion)	320 (A) / 915 (AC) Wh	915 Wh	500 Wh, floating	915 Wh	-
Nominal voltage in V	29.6	29.6	29.6	29.6	24
Final charging voltage in V	33.6	33.6	33.6	33.6	-
Total weight in kg	8.8 (A) / 11.0 (AC)	15.3	15.5	17.3 (S) / 17.7 (L)	T: 19.7 (S) / 20.2 (L) R: 18.9 (S) / 19.4 (L)
Motor weight without battery, in kg	5.0	9.3	11.3	11.3 (S) / 11.7 (L)	-
Weight of integrated battery, in kg	3.8 (A) / 6.0 (AC)	6.0	4.2	6.0	-
Shaft length in cm	48	51	62.5	62.5 (S) / 75 (L)	62.5 (S) / 75.5 (L)
Standard propeller (v = speed in km/h at p = power in W)	v10/p350	v10/p1100 weedless	v10/p1100	v10/p1100	Propeller B 12x10,5 WDR
Alternative propeller options	-	-	v10/p1100 weedless	v10/p1100 weedless	-
Maximum propeller speed in rpm at full load	1,200	1,450	1,100	1,450	1,100
Control	Throttle	Throttle	Tiller	Tiller	Tiller/throttle**
TorqLink	-	-	-	-	No
Steering	Connects to kayak steering, lockable	Connects to kayak steering, lockable	+/-60° lockable	+/-60° lockable	360° lockable
Tilting device	Manual, with impact protection	Manual, with impact protection	Manual, with impact protection	Manual, with impact protection	Manual, with impact protection
Trim device	Manual, 4-step	Manual, 4-step	Manual, 4-step	Manual, 4-step	Manual, 4-step
Stepless forward/reverse drive	Yes	Yes	Yes	Yes	Yes

* Torqeedo static thrust measurement is based on internationally accepted ISO standards. Static thrust figures for conventional trolling motors are typically measured differently, which results in higher values. To compare Torqeedo static thrust data with conventional trolling motors, add approximately 50% to the Torqeedo static thrust values.

** not included

(S) short version

(L) long version

(XL) extra-long version

CRUISE 6.0 T/R	CRUISE 10.0 T	CRUISE 12.0 R	CRUISE 3.0 FP	CRUISE 6.0 FP	CRUISE 12.0 FP
6,000	10,000	12,000	3,000	6,000	12,000
3,504	5,600	6,720	1,530	2,760	6,720
9.9 HP	20 HP	25 HP	-	-	-
15 HP	25 HP	25 HP	-	-	-
-	-	-	6 HP	9.9 HP	25 HP
-	-	-	8 HP	15 HP	25 HP
58	56	56	51	58	56
230	405	405	142	230	405
-	-	-	-	-	-
48	48	48	24	48	48
-	-	-	-	-	-
T: 21.3 (S) / 21.8 (L) R: 20.6 (S) / 21.0 (L)	T: 60.3 (S)/61.8 (L)/ 63.0 (XL) R: 59.8 (S)/61.3 (L)/ 62.5 (XL)	59.8 (S)/ 61.3 (L)/ 62.5 (XL)	12.8	14.7	33.5
-	-	-	-	-	-
-	-	-	-	-	-
62.5 (S) / 75.5 (L)	38.5 (S)/51.2 (L)/ 63.9 (XL)	38.5 (S)/51.2 (L)/ 63.9 (XL)	-	-	-
Propeller B 12,5x17 HSP	v22/p10k	v22/p10k	Propeller B 12x10,5 WDR	Propeller B 12x13 THR	v15/p10k
Propeller B 12x13 THR	v32/p10k v15/p10k	v32/p10k v15/p10k	Propeller B12x7 FLD	Propeller B13x11 FLD	v15/p10k (fold. prop.) v22/p10k v32/p10k
1,130	1,400	1,400	1,100	1,130	1,400
Tiller/throttle**	Tiller	Throttle**	Throttle**	Throttle**	Throttle**
With or without	No	Yes	No	Yes	Yes
360° lockable	+/-45°	+/-45°	-	-	-
Manual, with impact protection	Power tilt	Power tilt	-	-	-
Manual, 4-step	Manual, 4-step	Manual, 4-step	-	-	-
Yes	Yes	Yes	Yes	Yes	Yes

Part no.	Product	Description
Drives and batteries		
Ultralight		
1405-00	Ultralight 403 A	Ultralight outboard, 1 HP equivalent, with 320 Wh high-performance lithium battery, including charger, throttle with onboard computer (GPS-based range calculation) and emergency magnetic kill switch
1407-00	Ultralight 403 AC	Ultralight outboard, 1 HP equivalent, with 915 Wh high-performance lithium battery, including charger, throttle with onboard computer (GPS-based range calculation) and emergency magnetic kill switch
1408-00	Ultralight 1103 AC	Ultralight outboard, 3 HP equivalent, with 915 Wh high-performance lithium battery, including charger, throttle with onboard computer (GPS-based range calculation) and emergency magnetic kill switch
1416-00	Spare battery 320 Wh for Ultralight 403	High-performance lithium battery with integrated GPS receiver, 320 Wh. For all Ultralight 403 models
1417-00	Spare battery 915 Wh for Ultralight	High-performance lithium battery with integrated GPS receiver, 915 Wh. For all Ultralight models
Travel		
1153-00	Travel 603	High-efficiency outboard with integrated 500 Wh high-performance floating lithium battery, 2 HP equivalent, including onboard computer with GPS-based range calculation, charger, emergency magnetic kill switch, short shaft
1151-00	Travel 1103 CS	High-efficiency outboard with integrated 915 Wh high-performance lithium battery, 3 HP equivalent, including onboard computer with GPS-based range calculation and charger, emergency magnetic kill switch, short shaft
1152-00	Travel 1103 CL	As part no. 1151-00, but with long shaft
1155-00	Spare battery 500 Wh for Travel	High-performance lithium battery with integrated GPS receiver, 500 Wh. For Travel 503/603
1148-00	Spare battery 915 Wh for Travel	High-performance lithium battery with integrated GPS receiver, 915 Wh
Cruise		
1260-00	Cruise 3.0 RS	High-efficiency outboard, 6 HP equivalent, including connection to remote steering, cable set (4.4 m, 35 mm ²) including main switch and propeller B 12x10.5 WDR, short shaft version. Throttle not included - best paired with throttle part no. 1918-00
1261-00	Cruise 3.0 RL	As part no. 1260-00, but with long shaft and cable set (4.3 m)
1262-00	Cruise 6.0 RS TorqLink	High-efficiency outboard with TorqLink, 9.9 HP equivalent, including connection to remote steering, cable set (4.4 m, 35 mm ²) including main switch and propeller B 12.5x17 HSP, short shaft version. Throttle not included - best paired with TorqLink throttle part no. 1976-00
1262-10	Cruise 6.0 RS	As part no. 1262-00, but without TorqLink, for systems with Power 24-3500 (install according to ISO16315 if applicable)
1263-00	Cruise 6.0 RL TorqLink	As part no. 1262-00, but with long shaft and cable set (4.3 m)
1263-10	Cruise 6.0 RL	As part no. 1262-10, but with long shaft and cable set (4.3 m)
1264-00	Cruise 3.0 TS	High-efficiency outboard, 6 HP equivalent, with tiller steering, integrated onboard computer with GPS-based range calculation, cable set (4.4 m, 35 mm ²) including main switch and propeller B 12x10.5 WDR, short shaft version
1265-00	Cruise 3.0 TL	As part no. 1264-00, but with long shaft and cable set (4.3 m)
1266-00	Cruise 6.0 TS	High-efficiency outboard, 9.9 HP equivalent, with tiller steering, integrated onboard computer with GPS-based range calculation, cable set (4.4 m, 35 mm ²) including main switch and propeller B 12.5x17 HSP, short shaft version
1267-00	Cruise 6.0 TL	As part no. 1266-00, but with long shaft and cable set (4.3 m)
1268-00	Cruise 3.0 FP	High-efficiency pod motor (fixed position), 6 HP equivalent. Cable set (4.4 m, 35 mm ²) including main switch and propeller B 12x10.5 WDR. Throttle not included - best paired with throttle part no. 1918-00
1269-00	Cruise 6.0 FP TorqLink	High-efficiency pod motor (fixed position) with TorqLink, 9.9 HP equivalent. Cable set (4.4 m, 35 mm ²) including main switch and propeller B 12x13 THR. Throttle not included - best paired with TorqLink throttle part no. 1976-00
1243-20	Cruise 10.0 TS	High-efficiency outboard, 20 HP equivalent, with tiller steering, integrated onboard computer with GPS-based range calculation, cable set (4.5 m, 95 mm ²) including main switch and v22/p10k propeller, short shaft version
1244-20	Cruise 10.0 TL	As part no. 1243-20, but with long shaft
1245-20	Cruise 10.0 TXL	As part no. 1243-20, but with extra-long shaft

Part no.	Product	Description
1280-00	Cruise 12.0 RS TorqLink	High-efficiency outboard with TorqLink, 25 HP equivalent, including connection to remote steering, cable set (4.5 m, 95 mm ²) including main switch and v22/p10k propeller, short shaft version. Throttle not included - best paired with TorqLink throttle part no. 1976-00
1281-00	Cruise 12.0 RL TorqLink	As part no. 1280-20, but with long shaft
1282-00	Cruise 12.0 RXL TorqLink	As part no. 1280-20, but with extra-long shaft
1283-00	Cruise 12.0 FP TorqLink	High-efficiency pod motor (fixed position) with TorqLink, 25 HP equivalent, including cable set (4.5 m, 95 mm ²) including main switch and v15/p10k propeller. Throttle not included - best paired with TorqLink throttle part no. 1976-00

Power

2106-00	Power 24-3500	High-performance lithium battery, with 3,679 Wh nominal energy, rated voltage 25.6 V, weight 25.3 kg, with innovative battery management system including numerous protective functions, waterproof to IP67; includes data cable (5 m). Compatible with Cruise 2.0 and Cruise 3.0. If used with Cruise 4.0 or Cruise 6.0 please install according to ISO16315 if applicable
2104-00	Power 48-5000	High-performance lithium battery with TorqLink, with 5,275 Wh nominal energy, rated voltage 44.4 V, weight 37 kg, with innovative battery management system including numerous protective functions, waterproof to IP67; includes TorqLink data cable (0.9 m)

Accessories

Extras

1925-00	Travel bags (2-piece)	For transporting and storing Travel models. Includes two bags, one for the motor (including tiller and accessories) and one for the battery.
1926-00	Travel battery bag	For transporting and storing Travel batteries
1977-00	USB adapter for Travel and Ultralight	USB adapter for charging USB devices from Travel or Ultralight batteries. For use only with batteries part no. 1146-00, 1147-00, 1148-00, 1155-00, 1416-00 and 1417-00
1931-00	Protective cover Travel	Protects the Travel's motor cable from UV fading and the shaft head from dirt. Water-resistant and breathable
1924-00	TorqTrac	Bluetooth dongle allows the use of the TorqTrac smartphone app to display the onboard computer, remaining range, map and more on your smartphone. For Cruise, Travel and Ultralight. Built-in Bluetooth for the TorqLink throttle (1979-00) and in the aluminium throttles (1949-00 to 1952-00)

Charging equipment

1133-00	Charger 90 W for Travel and Ultralight batteries	90 W charger for electric sockets rated 100-240 V and 50-60 Hz. For use only with batteries part no. 1146-00, 1147-00, 1148-00, 1155-00, 1416-00 and 1417-00
1128-00	12/24 V charger cable for Travel and Ultralight	Allows Travel and Ultralight batteries to be charged from a 12/24 V power source. When charging from a lead/AGM battery, please ensure that undervoltage protection is in place
1997-00	Solar charging cable for Ultralight and Travel	Allows Travel and Ultralight batteries to be charged from a third-party solar panel up to 160 W with a standard MC4 connection. For use only with batteries part no. 1146-00, 1147-00, 1148-00, 1155-00, 1416-00 and 1417-00
1132-00	Sunfold 50	Foldable 50 Wp solar panel, convenient size, highly efficient, plug & play connections for waterproof charging of the Travel and Ultralight batteries manufactured since 2015
2206-20	Charger 350 W for Power 24-3500	DC charge current 10 A; charges the Power 24-3500 from 0 to 100% in a maximum of 11 hours; waterproof to IP65
2210-00	Fast charger 1700 W for Power 24-3500	DC charge current 60 A; charges the Power 24-3500 from 0 to 100% in <3 hours; waterproof to IP65
2207-00	Solar charge controller for Power 24-3500	Solar charge controller for Power 24-3500 with MPPT regulation. Enables safe and efficient charging with up to 232 W (solar modules not included)
2211-00	Fast solar charge controller for Power 24-3500	Fast solar charge controller for Power 24-3500 with MPPT regulation. Enables safe and efficient charging with up to 65 A battery current (solar modules not included)
2213-00	Charger 650 W for Power 48-5000	TorqLink-ready charger, DC charge current 13 A; charges the Power 48-5000 from 0% to 100% in a maximum of 10 hours; waterproof IP65
2212-00	Fast charger 2900 W for Power 48-5000	TorqLink-ready charger, DC charge current 50 A; charges the Power 48-5000 from 0 to 100% in <3 hours; waterproof to IP65
2218-00	Solar charge controller for Power 48-5000	Solar charge controller for Power 48-5000 with MPPT regulation. Enables safe and efficient charging with up to 325 W. Automatically turns battery on when solar energy is available for charging (solar modules not included)



You can find the prices on our website:
www.torqueedo.com

Ordering information

Part no.	Product	Description
Propellers, fins and anodes		
1912-00	Spare propeller v10/p350	For Ultralight 403 (Ø 200 mm)
1972-00	Spare propeller v10/p1100	Standard propeller for Ultralight 1103, spare propeller for Travel 603/1103, weedless
1973-00	Spare propeller v10/p1100	Standard propeller for Travel 603/1103, spare propeller for Ultralight 1103
1905-00	Anode Al Cruise 2.0/3.0/4.0/6.0 R/T/FP, Ultralight 1103 and Travel 603/1103	Anode made of aluminium for the operation of Cruise 2.0/3.0/4.0/6.0 R/T, Travel 603/1103 and Ultralight 1103; for use in fresh and salt water. Attaches to the propeller shaft
1984-00	Propeller B 12 x 10.5 WDR	Universal propeller for all Cruise 3.0 models
1985-00	Propeller B 12 x 8 FLD	Folding propeller for Cruise 3.0 FP
1986-00	Propeller B 12 x 13 THR	Thrust propeller for Cruise 6.0 models, standard propeller for Cruise 6.0 FP
1987-00	Propeller B 12.5 x 17 HSP	High-speed propeller for Cruise 6.0, standard propeller for Cruise 6.0 R/T
1988-00	Propeller B 13 x 11 FLD	Folding propeller for Cruise 6.0 FP
1992-00	Anode set Al Cruise 3.0/6.0 FP with folding propeller	Anode set for Cruise 3.0/6.0 FP models with folding propeller (part no. 1985-00, 1988-00); consists of four anodes for attachment to the propeller and hull bracket; made of aluminium for use in fresh and salt water
1995-00	Anode set Al Cruise 3.0/6.0 FP	Anode set for Cruise 3.0/6.0 FP models with standard propeller (part no. 1984-00, 1986-00); consists of three anodes for attachment to the propeller shaft and hull bracket; made of aluminium for use in fresh and salt water
1937-00	Spare propeller v15/p10k	Thrust propeller for all Cruise 10.0/12.0 models, optimised for high thrust for displacement vessels
1961-00	Spare propeller v22/p10k	Universal propeller for all Cruise 10.0/12.0 models for medium speeds
1938-00	Spare propeller v32/p10k	High-speed propeller for all Cruise 10.0/12.0 models, optimised for high speeds and planing
1945-00	Folding propeller v15/p10k	Folding propeller for Cruise 10.0/12.0 FP
1935-00	Anode set Al Cruise 10.0/12.0 R/T	Anode set for Cruise 10.0/12.0 R/T with standard propeller; consists of 1 x shaft anode and 2 x half-ring anodes. For use in fresh and salt water
1947-00	Anode set Al Cruise 10.0/12.0 FP with folding propeller	Anode set for Cruise 10.0/12.0 FP with folding propeller (with part no. 1945-00). Consists of 2 x anodes for attachment to the propeller, 2 x half-ring anodes, 1 x anode for attachment to the pylon. Made of aluminium for use in fresh and salt water
9259-00	Fin for Cruise 10.0/12.0 R/T	Spare fin. Protects the outboard when running aground

Cable, control, steering

1976-00	TorqLink throttle with colour display	Top-mount throttle for TorqLink systems, with integrated TorqTrac and WLAN. Colour display shows all critical system info, GPS-based speed and remaining range. Includes a 3 m TorqLink data cable
1978-00	Emergency magnetic kill switch for TorqLink throttle	Emergency stop key and immobiliser for part no. 1976-00, TorqLink throttle with colour display
1949-00	Throttle Sail side-mount	TorqLink throttle for sailboats (side-mount) with built-in TorqTrac and 1.28" display. Includes data cables (0.9 m and 5 m), on/off button, emergency off button, TorqLink Gateway, TorqLink Terminator and mounting material
1950-00	Throttle side-mount	TorqLink throttle for motorboats (side-mount) with power trim and tilt, TorqTrac and 1.28" display. Includes data cables (0.9 m and 5 m), key switch, kill switch, TorqLink Gateway, TorqLink Terminator and mounting material
1951-00	Throttle top-mount	TorqLink throttle for motorboats (top-mount) with power trim and tilt, TorqTrac and 1.28" display. Includes data cables (0.9 m and 5 m), on/off button, emergency off button, TorqLink Gateway, TorqLink Terminator and mounting material
1952-00	Dual throttle top-mount	TorqLink throttle for twin-installation motorboats (top-mount) with power trim and tilt, TorqTrac and 1.28" display. Includes data cables (2 x 0.9 m and 2 x 5 m), key switch, emergency off button, 2 x TorqLink Gateway, 2 x TorqLink Terminator and mounting material
1966-00	Display gateway single	Allows NMEA-2000 devices to access and display key motor and battery information from TorqLink-equipped single drive systems
1968-00	Display gateway twin	Allows NMEA-2000 devices to access and display key motor and battery information from TorqLink-equipped twin drive systems
1975-00	Hybrid safety kit	Disables the drive system while charging from shore power. Installation by boat builder or certified electrician; additional parts required
1956-00	TorqLink extension cable 3 m	TorqLink extension cable (8-pin) for the extension of the TorqLink backbone, 3 m long
1957-00	TorqLink extension cable 5 m	As part no. 1956-00, 5 m long
1981-00	TorqLink extension cable 15 m	As part no. 1956-00, 15 m long



You can find the prices on our website:
www.torqueedo.com

Part no.	Product	Description
1982-00	TorqLink T-cable angled 0.9 m	TorqLink T-cable (8-pin) with angled plug, 0.9 m, for integration of TorqLink components into TorqLink backbone
1983-00	TorqLink T-cable 0.9 m	As part no. 1982-00, but with straight plug to device
1991-00	Motor cable extension Cruise 3.0/6.0	Cruise 3.0/6.0 cable set for extending the cable between motor and main switch, 2 m long, with plugs
1974-00	Spare bridge cable Power 48-5000	Bridge cable for connecting two Power 48-5000 batteries in parallel, 0.22 m long, 35 mm ² Includes pole screws
1990-00	Cable set 3rd-party batteries - Cruise 6.0 TorqLink	Cable set for the use of lead, AGM or LFP batteries (incl. Power 24-3500) with your Cruise 6.0 TorqLink
1979-00	Cable set 3rd-party batteries - Cruise 10.0/12.0	Cable set for the use of lead, AGM or LFP batteries (incl. Power 24-3500) with your Cruise 10.0 from model year 2021 onwards or Cruise 12.0
2215-00	On/off switch for Power 48-5000	Switch for activating/deactivating the Power 48-5000 when used with or without Cruise system
2217-00	TorqLink gateway set	Gateway allows communication and connection between products with and without TorqLink. Also controls Power 48-5000 battery banks without Torqeedo motor. Includes on/off switch for Power 48-5000 and 5 m extension cable
1918-00	Throttle for Travel, Ultralight and Cruise models without TorqLink	Throttle with display of battery status, GPS-based speed and remaining range. Enables operation with throttle instead of tillers for Travel models. Spare part for Ultralight and Cruise models without TorqLink. Includes data cables, 1.5 m and 5 m (5-pin)
1914-00	Emergency magnetic kill switch	Emergency magnetic kill switch as spare part for throttle 1918-00 as well as Travel and Cruise T
1921-00	Data cable (5-pin) 1.5 m	Extension cable for Travel, Ultralight and Cruise models allows a greater distance between throttle/tiller and motor
1922-00	Data cable (5-pin) 5 m	As part no. 1921-00, 5 m long
1934-00	Spare cable bridges Power 24-3500	Cable set for connecting two additional Power 24-3500 to a battery bank; includes one series bridge cable (0.4 m long) with battery terminal connectors; 4 x parallel bridge cables (0.4 m long) with ring terminal connectors including nuts; 2 x 5-pin data cable (1.5 m long)
2304-00	On/off switch for Power 24-3500	Switch for activating/deactivating the Power 24-3500 when used without Cruise system or when used with a TorqLink throttle; With LED; waterproof to IP65
1920-00	Motor cable extension for Travel and Ultralight	Cable connection extension between battery and motor for Ultralight and Travel models allows a greater distance (2 m) between battery and motor; waterproof plug connections
1927-00	Spare parts set Travel	Set for Travel consisting of emergency kill switch, battery attachment pin and steering fixing pin
1919-00	Long tiller arm	60 cm tiller tube extension for all Travel and Cruise T models
1970-00	Kayak bracket for Ultralight 403	Optimised kayak mount for Ultralight 403 (part no. 1404-00 to 1407-00)



A global network

Service centres and service partners around the world

Torqueedo service centres

Torqueedo GmbH
Claude-Dornier-Str. 1, Geb. 901
82234 Wessling
Germany
T +49 (0) 8153 - 92 15 - 126
F +49 (0) 8153 - 92 15 - 329
service@torqueedo.com

Torqueedo Inc.
171 Erick Street, Unit D-2
Crystal Lake, IL 60014
USA
T +1 (815) 444 8806
F +1 (815) 444 8807
service_usa@torqueedo.com

Torqueedo Asia Pacific Ltd
Athenee Tower, 23rd Floor
63 Wireless Road, Lumpini,
Pathumwan, Bangkok 10330
Thailand
T +66 (0) 212 680 15
service_apac@torqueedo.com



Imprint:

Editor:	Tess Smallridge
Concept:	Tess Smallridge, Eva Flamme, Oliver Glück
Graphics design:	Eva Flamme
Photography:	Gilles Martin-Raget (1) Christian Brecheis (2/4/5/9/12/13/15/ 16/18/19/23b/25/26/32/35/37/42/43/44/ 45/51/55) Sandra Eckhardt, Jan Ott (Products) Tim Marcour (7/17/20/21/23/30/56) Flo Hagen (10/11/32/33/52/53) Andrea Muscatello (22) Julien Gazeau (2/24) Spirit Yachts / Waterline Media (27) Christophe Launay (36) Henrik Ljungqvist (41)
3D renderings:	Modus X (31/34/36) Schlagheck Design (8/22/26)
Product design:	Schlagheck Design
UX/UI design:	Kiel, Industrial Design (35/40)
Printing:	AZ Druck und Datentechnik GmbH

www.bouwmeesterwatersport.nl



Torqueedo products are engineered and manufactured to the highest quality standards. Torqueedo motors and accessories are designed for long use in difficult conditions and must prove this in testing in contin-

uous use. Every single product is carefully inspected before delivery. Certification to the internationally recognised quality management standard ISO 9001 is a guarantee of the quality of our products.



Torqueedo service centre



Torqueedo service partners: You can find a complete list at www.torqueedo.com > Service centres

Charting a new course

Digitalisation, electrification and autonomous vehicles are changing how we get around. Torqeedo is bringing new mobility onto the water – and you can profit from the new technology.

How we move people and products – in fact, our entire mobility culture – is changing. Today, we navigate the ever-more complex urban infrastructure with our smartphones, changing from rent-a-bike to Uber pool to subway travel in an instant. Digitalisation and connectivity are driving a mobility revolution not seen since the advent of combustion engines.

Waterways as a way out

These new, smart and interconnected mobility services are also extending onto the water. By 2050, the global population is projected to reach 10 billion, with 75% of people living in cities. Facing this rapid population shift and the resulting gridlock of land-based transportation, urban planners are looking to the waterways that grace many metropolises to ease the burden on the road and rail infrastructure.

Many old canals and rivers that had been covered by concrete for decades are being reopened

and integrated into public transport networks. Eight all-electric commuter ferries are operating in Bangkok, Thailand, powered by twin Torqeedo Cruise 10.0 electric outboards. Electric ferries are contributing to cleaner air in metropolitan areas and lowering the carbon footprint of on-water transport. Commercial vessels cover their roofs and sunlit surfaces with solar panels to generate energy and reduce pollution, or even go completely emission-free.

Because of the focus on building a climate-neutral economy, electric mobility is growing exponentially year after year.

A smart business choice

The mobility revolution goes beyond exchanging motors; the whole operational system is being reprogrammed. Amsterdam is the first large city to have started trials of autonomous transport boats for goods distribution. On urban canals or rivers we will soon see autonomous ferries or water taxis that

can be ordered by smartphone. As 21st-century technology shouldn't be powered by 20th-century engines, electric motors are the propulsion technology of choice for this new application field.

Smart, connected electric mobility means the world's great cities can improve their air and water quality, protect the climate, and simultaneously improve their citizens' quality of life. We're proud to be part of this global transformation. But the switch to electric is also a smart business choice: reduce operating costs, improve the user experience and minimise your carbon footprint, while setting your company apart. Powering your business with environmentally friendly drive systems from Torqeedo may even provide a competitive advantage for funding, official permits and customers in the marketplace.



Scan
Torqeedo's
commercial
catalogue

Now is the time

Torqeedo provides a complete, integrated and proven electric propulsion system for your commercial project. With a battery capacity warranty of up to nine years and world-wide service, now is the time to lower your operating costs and carbon footprint with a high-tech electric mobility system from Torqeedo.

It all adds up

- Save 100% of your petrol or diesel costs and instead:
- + Spend a fraction on electricity and battery write-off
- + Reduce maintenance costs
- + Enjoy high reliability

= **If you're out on the water 100 days a year or more, you may save money by going electric.**



Electric ferries in Usedom, Germany

What we offer



Diagnostics and service: Torqeedo specialists can solve many hardware and software issues remotely.



Experts on call to answer questions or schedule service.



On-site support: A Torqeedo technician will travel to your place of business to perform maintenance or repairs.

We'll be pleased to provide you with a calculation customised to your requirements:

info@torqeedo.com

TORQUEEDO



Bouwmeester Watersport

**Bouwmeester Watersport
Binnendams 40
3373 AD Hardinxveld-Giessendam
0184-615178
www.bouwmeesterwatersport.nl**

Part no. 8045-00



This product is made of FSC® certified and other controlled materials.

Goods are delivered exclusively according to our Terms of Sale and Delivery according to Torqueedo's current Terms and Conditions of Business. We reserve the right to make any changes, including pricing, at any time.